

TEACHING GUIDE

Teaching Of The Laser Sensor Series LAS

For further information please see the data sheet at <http://www.waycon.biz/products/laser-sensors/>

INTRODUCTION

Every sensor is delivered with the factory setup (max. measuring range). The teach-in feature was designed to choose a smaller range within the nominal measuring range for optimizing the resolution and linearity. Output current, voltage and alarm output adapt to the new range. Two positions must be taught.

- The first teach-in position aligns with 0 V or 4 mA, the second position aligns with 10 V or 20 mA.
- These teach-in positions are always just at the border of the new range (inside the measuring range).
- The sensor may be taught more than 10,000 times in its lifetime
- The sensor can always be reset to the factory settings.
- The sensor may be taught with the teach button or via the external teach input.
- During the teach-in process, the red LED and the alarm output provides a feedback.
- The red LED on the back side of the sensor and the alarm output indicate "run" mode if an object is within the measuring range.

Attention:

Within 5 minutes after power on, the sensor can be taught via the button or the teach-in wire. After 5 minutes, the teach-in button will be locked preventing accidental adjustment. The teach-in wire is active all the time.

Upper figure: Example of a taught measuring range.

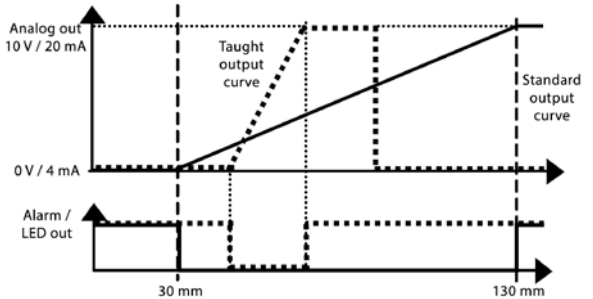

Lower figure: Example of a reverse taught measuring range.

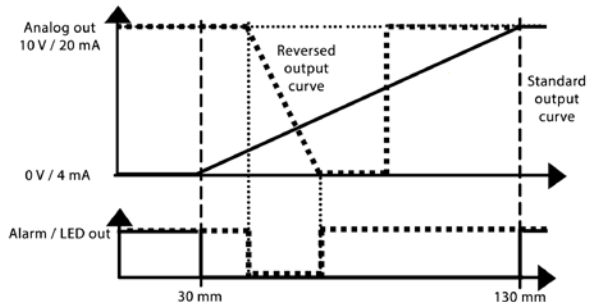

LINEARITY / RESOLUTION - LAS-T, LAS-T5 SERIES

When teaching the measurement range, it is recommended to always select the smallest possible range, because this way the resolution is increased and the linearity error decreased. Also keep in mind that the distance between sensor and target should be as small as possible. MR stands for the teached measurement range.

LAS-T-40, LAS-T5-40

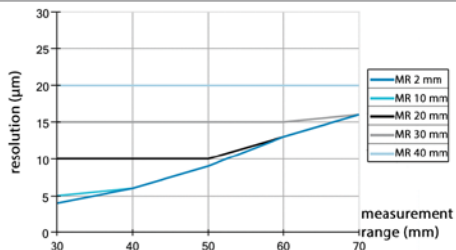
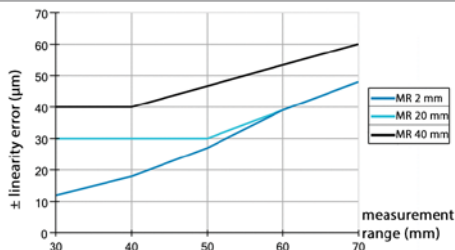

LAS-T-100, LAS-T5-100

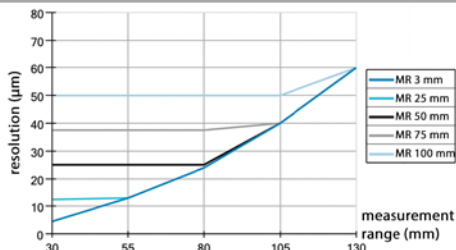
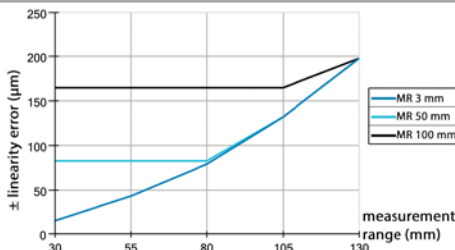

LAS-T-250, LAS-T5-250

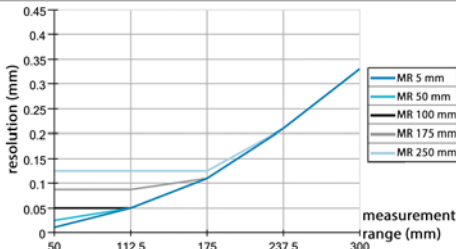
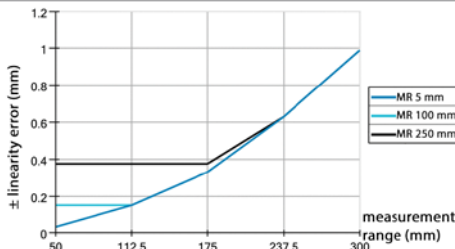

LAS-T-500, LAS-T5-500

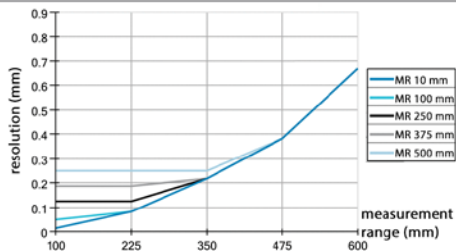
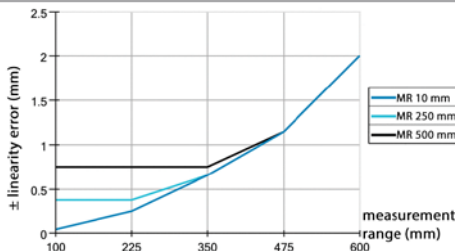

LINEARITY / RESOLUTION - LAS-T, LAS-T5 SERIES

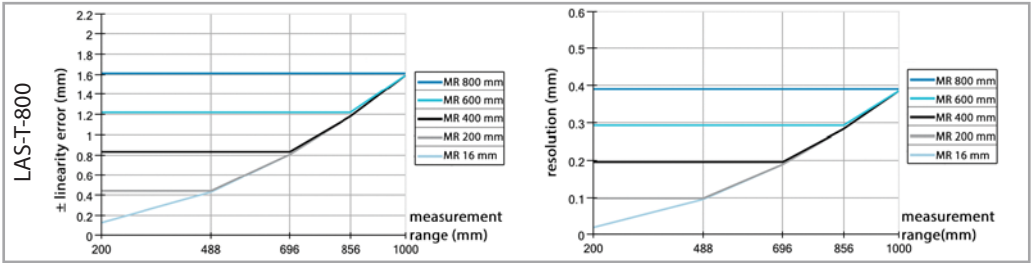

LINEARITY / RESOLUTION - LAS-TB SERIES

When teaching the measurement range, it is recommended to always select the smallest possible range, because this way the resolution is increased and the linearity error decreased. Also keep in mind that the distance between sensor and target should be as small as possible. MR stands for the taught measurement range.

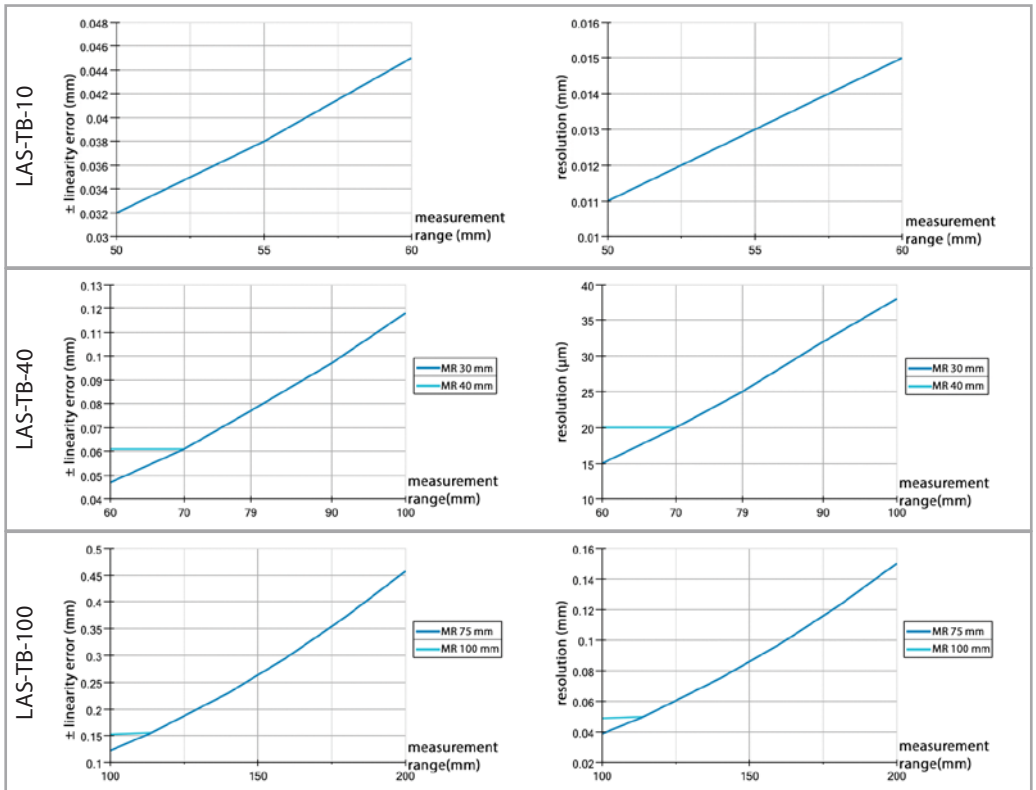

LINEARITY / RESOLUTION - LAS-TM SERIES

When teaching the measurement range, it is recommended to always select the smallest possible range, because this way the resolution is increased and the linearity error decreased. Also keep in mind that the distance between sensor and target should be as small as possible. MR stands for the teached measurement range.

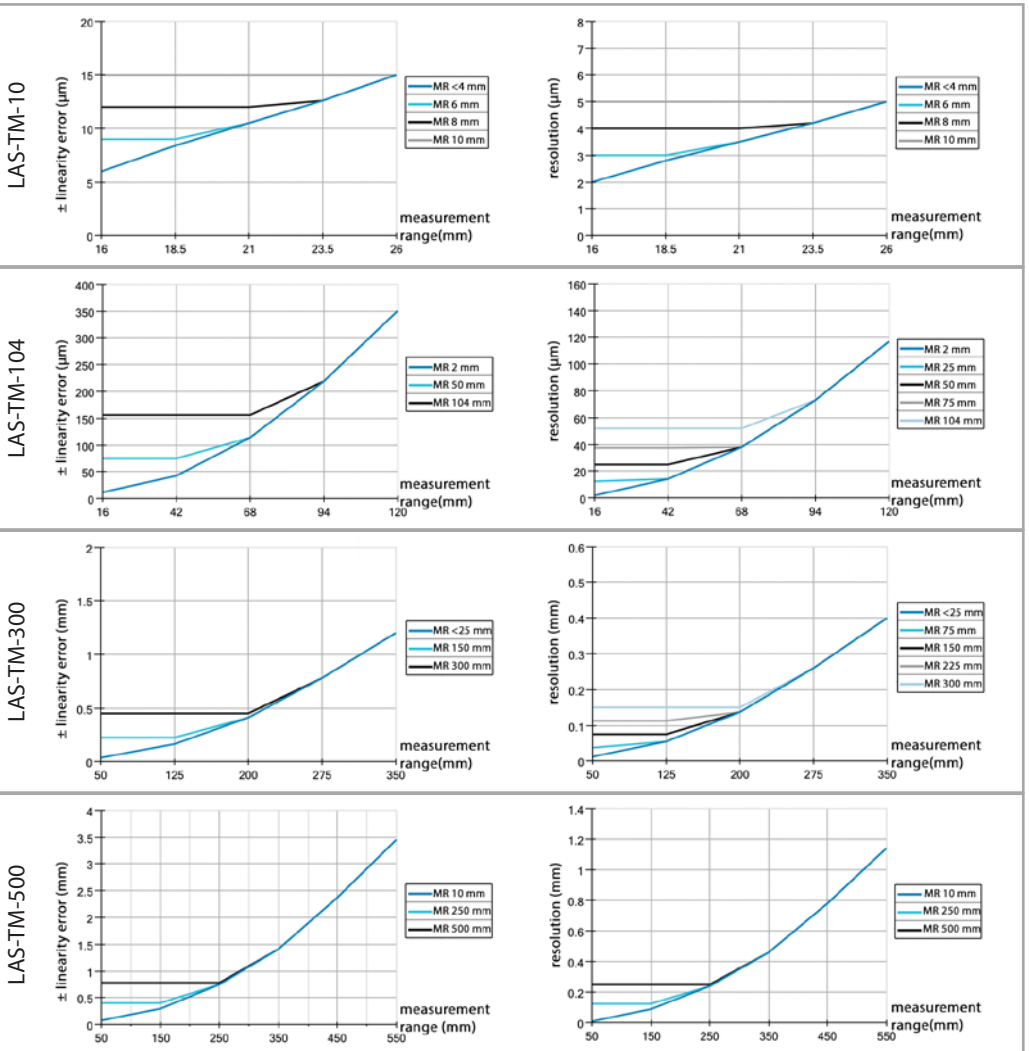

Teaching a new measuring range:

Within 5 minutes after power-up, the button may be used to teach a new range. After finishing a teach procedure, the 5 minutes starts again. After the 5 minutes, the sensor does not respond to pressing the button. Seven steps to teaching a new measuring range:

1. Press (and hold) the button. The red LED will turn on, if the sensor can be taught.
2. Hold down the button for 5 more sec. The LED will start to blink.
3. Release the button.
4. Place a target at the first new position of the measuring range. This is the position that will later produce 0 V or 4 mA.
5. Briefly press the button again. The LED will stop blinking and will stay on for about 3 sec to indicate that the first position has been stored. Then the LED will blink again.
6. Now place the target at the second position (the other end of the new range), which will produce 10 V or 20 mA.
7. Briefly press the button again. The LED will stop blinking and will stay on for about 3 sec to indicate that the second position has been stored. The LED will then turn off and blink once more. Now the sensor is ready to measure.

The new, smaller operating range is now set. The red LED now indicates whether an object is within the new range (LED OFF) or not (LED ON).

If one of the new borders of the range was outside the standard range or the two positions were too close to each other, then the new settings are not valid. The sensor will respond with an extended blinking at the end of the teach procedure. The previous settings are still valid and the new settings are lost.

Timing of the teach procedure:

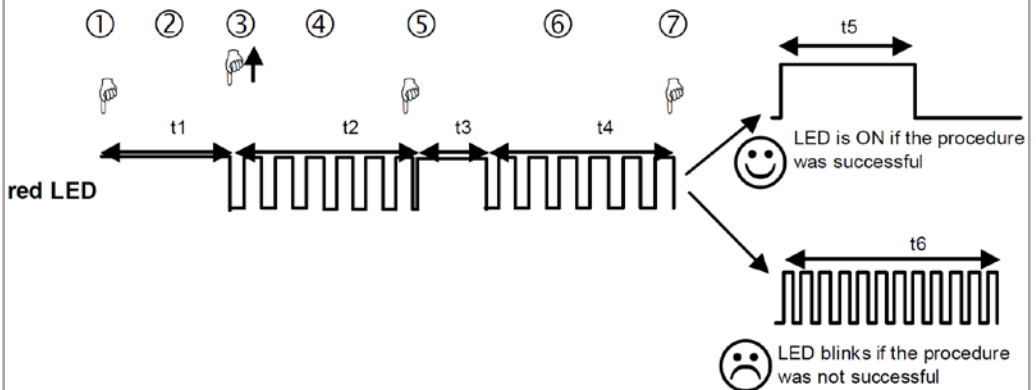

HOW TO RESET THE FACTORY SETTINGS BY TEACH BUTTON

Within 5 minutes after power up, the button may be used to reset the sensor back to the factory settings. After finishing a teach procedure, the 5 minutes starts again. After the 5 minutes, the sensor does not respond to the button.

1. Push the button. The red LED will turn on, if the sensor can be taught.
2. Hold down the button further 5 sec. The LED will start to blink. DO NOT RELEASE the button now. Wait another 10 sec until the LED is ON without blinking. Factory settings have been restored to the sensor.
3. Release the button.

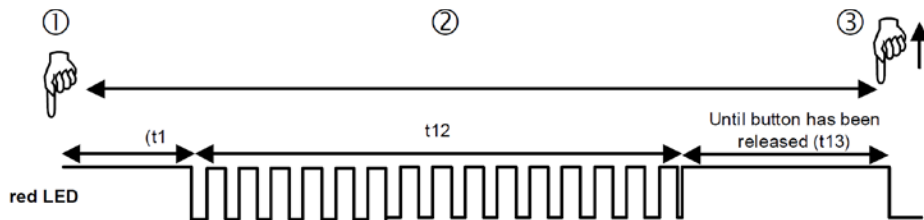

TEACHING BY TEACH LINE

Teaching the sensor via the external teach input is equivalent to the teaching procedure via the button. There is no 5 min. time limit. The sensor may be taught at any time. In addition to the LED, the alarm output is used to indicate the state of the sensor for an external digital controller.

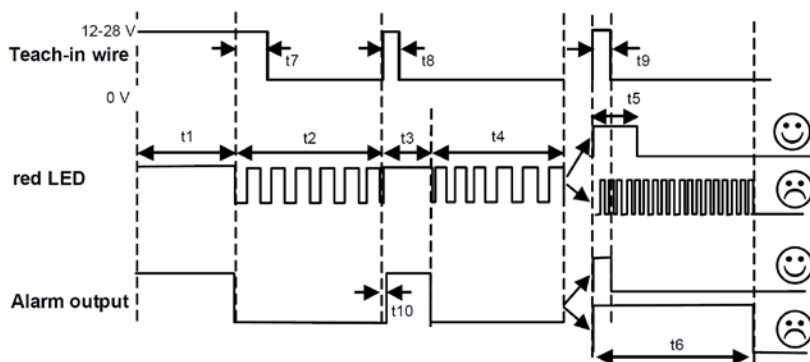

Delay between teach signal and response on alarm output:

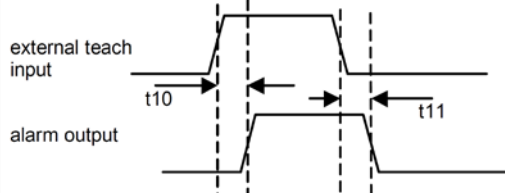

Input circuit:

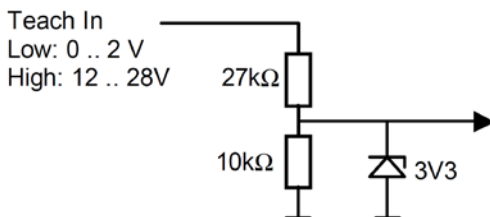

HOW TO RESET THE FACTORY SETTINGS BY TEACH LINE

Teaching the sensor via the external teach input is equivalent to the teaching procedure via the button. There is no 5 min. time limit. The sensor may be taught at any time. The alarm output can be used as an acknowledge signal for a control system.

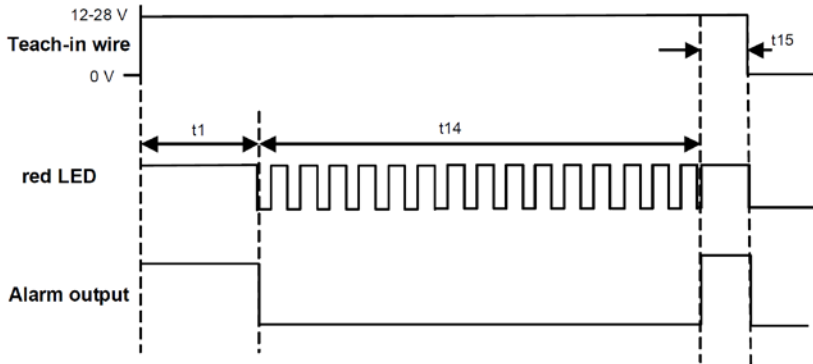

Delay between teach signal and response on alarm output:

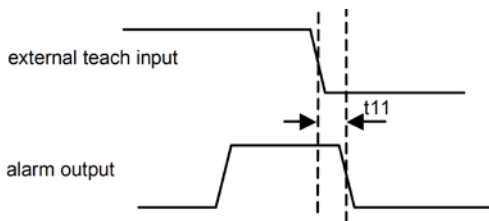



LEGEND

Time	Description of timing functions	Value	Comment
t1	Minimum button hold time to enter teach mode	5 s	Using the button, this feature can only be used within 5 minutes after power-up. Using the external teach input, it may be used at any time.
t2	Maximum waiting time after teaching the first position.	< 20 s	If the button has not been pushed during this interval, the sensor will leave the teach mode without any changes.
t3	LED on as response for the first position.	approx 3 s	
t4	Maximum waiting time after teaching the second position.	< 20 s	If the button has not been pushed during this interval, the sensor will leave the teach mode without any changes.
t5	LED on and "OK response" after the second position.	approx 3 s	
t6	LED Blinking for "NOT OK response" after teaching the second position.	approx 5 s	
t7	Minimal time between high/low transition of alarm output high/low transition of the external teach input at the beginning of the teach.	1 ms	
t8	Pulse lengths on external teach input for first position.	30...2000 ms	
t9	Pulse lengths on external teach input for second position.	30...2000 ms	
t10	Delays between teach signal and response on alarm output at the rising edge of the signal.	< 20 ms	
t11	Delay between teach signal and response on alarm output at the falling edge of the signal.	< 10 ms	
t12	Minimum blinking time for the reset to factory settings with button.	10 s	
t13	Blinking time after reset to factory settings.	> 0,2 s	As long as the button is down or the external teach input is high.
t14	Minimum blinking time for the reset to factory settings with external teach input.	10 s	
t15	Minimum high time of the external teach input after the alarm output has been set at the end of the setting of the factory settings.	0,2 s	