

DEEneo | LVDT

Digital signal converter for inductive sensors (LVDT)
for DIN rail mounting

- Digital signal processing by microcontroller
- Digitalization via 16 bit AD converter
- Linearisation of sensor signal
- Signal adjustment via SET button or software
- Cable break detection
- Alarm signal and switching output
- DIN rail mounting



DESCRIPTION

The **DEEneo** signal conditioner was developed for operating inductive LVDT sensors (full bridge). The electronics supply the sensor and convert the sensor signal into a standardized, analogue output signal with the help of a microcontroller.

DEEneo supports the operation of all LVDT sensors. The primary coil of the connected sensor is excited with a sinusoidal signal. To determine the sensor position, the secondary coil signals are calculated differentially and are used to generate an analog output signal. The internal, ratiometric signal processing is digital and guarantees high resolution and immunity to external influences (EMC).

The frequency and amplitude can be set using the **eddySetup** configuration software for optimum performance of the measuring chain. A push button (SET button) is used for the basic configuration and to set the measuring range limits - this enables quick and easy adaptation to the customer's application. Extended functions such as alarm and switching outputs can be configured as required via the USB interface.

Please note: Where possible, eddylab calibrates the sensor and electronics together as a measuring chain. The sensor characteristic curve can be linearized to meet the highest demands on the accuracy.

TECHNICAL DATA

MODEL	DEEneo
Output signal	0...20 mA, 4...20 mA (load <300 Ohm) 0...5 V, ± 5 V; 0...10 V, ± 10 V
Output protection	signal output impedance 150 Ohm
Power supply	9...36 VDC
Power consumption	70 mA at 24 VDC, 130 mA at 12 VDC
Sensor supply	standard: 3V / 3.3 kHz, can be modified by software
Settings (factory setting)	frequency, amplitude, output signal
Resolution	16 bit
Signal processing	digital via microcontroller
Signal adjustment	via SET-button or software
Filter corner frequency	digital adjustable, standard 300 Hz
Linearisation of sensor	yes, optionally possible
Isolation stability	> 500 VDC
Reverse protection	yes
Overvoltage protection	output: 16 V bipolar suppressor diode / permanent overvoltage up to 24 V input: Bipolar suppressor diode 36 V / Polyfuse 0.5 A on sensor side: 12 V
Switching output	open drain up to 60 V, max. 115 mA
Alarm output	open drain up to 60 V, max. 115 mA
Cable break detection	yes
Operating temperature	-40...+85 °C
Storage temperature	-40...+85 °C
EMC	EN IEC 61326-1:2021
Mounting	on 35 mm DIN rail in accordance with DIN EN 60715
Dimensions	77 x 75 x 26 mm

TECHNICAL DRAWING

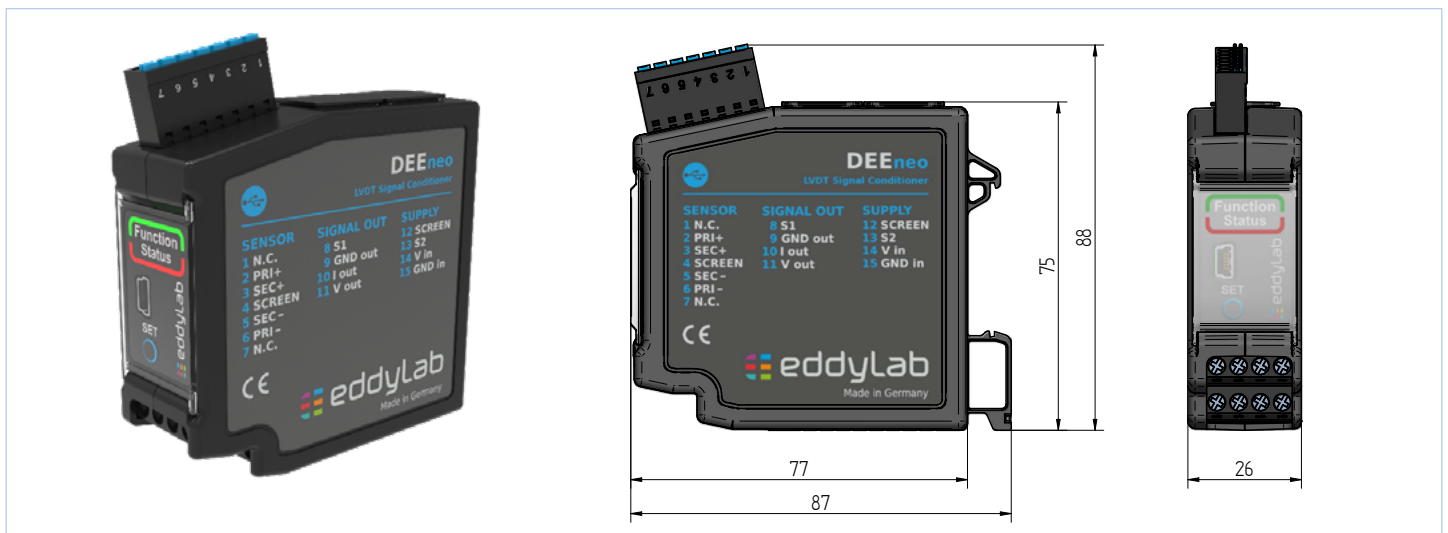

CONNECTION

DEEneo is designed to operate all commercially available LVDT sensors.

- LVDT sensors with 4-wire connection cable (e.g. eddylab LVDTs): Please refer to the table below or the diagram on the right.
- LVDT sensors with 5-core connection cable: The center tap (ends of both secondary windings) does not need to be connected. Alternatively, it can also be connected to terminal 1 or 7.
- LVDT sensors with 6-wire connection cable: The ends of both secondary windings (see sensor data sheet) must be connected. These can then be connected to terminal 1 or 7.

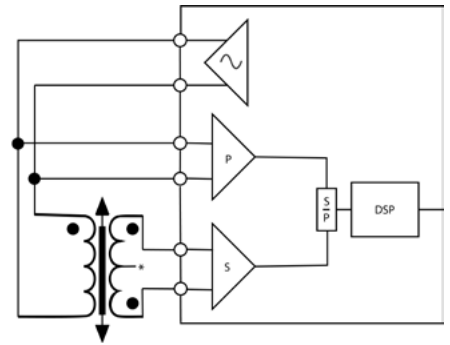

CONNECTION DATA

CLAMP	TECHNOLOGY	MAX. WIRE CROSS-SECTION	NOTE
1-7	Push-in	1,5 mm ²	Wire end ferrule length 12 mm
8-15	Screw	2,5 mm ²	Torque 0,5 Nm

ASSIGNMENT

CLAMP	FUNCTION	NOTE	WIRE COLOUR OF EDDYLAB CABLES	
			TPE CABLE	PTFE CABLE
1	N.C.	not connected		
2	PRI+	primary coil	white	white
3	SEC+	secondary coil	black	green
4	SCREEN			
5	SEC-	secondary coil	blue	brown
6	PRI-	primary coil	brown	yellow
7	N.C.	not connected		
8	S1	switching output		
9	GND out	GND signal		
10	I out	signal, e.g. 4...20 mA		
11	V out	signal, e.g. 0...10 V		
12	SCREEN			
13	S2	alarm-/ switching output		
14	V in	supply voltage		
15	GND in	GND supply		

CABLE BREAK DETECTION

The **DEEneo** electronics have an integrated cable break detection based on an impedance measurement of the LVDT's primary coil. If the sensor cable is cut, the impedance at the electronics changes independently of the core position and the cable break detection is triggered. This requires the connections of the primary coil of the sensor to be severed. A partial break only of the connections to the secondary coils does not activate this function.

To use the cable break detection function, an alarm-emitting device (signal lamp, acoustic warning device) is connected to terminal 13 (alarm S2) or the terminals are connected to an alarm input of a control unit (PLC).

REGULAR OPERATION

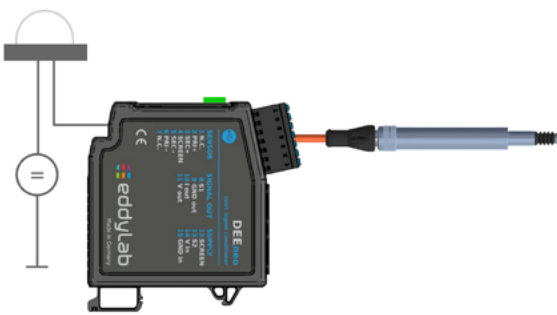

- "STATUS LED" lights up green.
- The analog signal output is active.
- The alarm output is deactivated.

CABLE BREAK

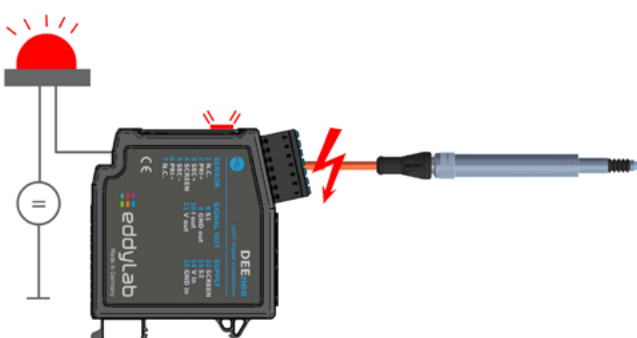

- In case of a cable break the alarm system is activated.
- „STATUS LED“ flashes red in case of an error.
- The analog signal output is deactivated. There is no current or voltage signal.

CONDITION		STATUS-LED
regular operation	switching output not activ	green
	switching output activ	blue
cable-break		red
measuring range exceeded		orange

SWITCHING OUTPUT

DEEneo has a programmable switching output. This is set to active as standard. The switching direction and switching point (threshold) can be configured using the SET button or **eddySetup** software.

Further settings can be made using the software:

- The hysteresis can be changed if required.
- The alarm output (S2) can also be used as a second switching output.

SOFTWARE EDDYSETUP

The **eddySetup** configuration tool is available at www.eddylab.com.

The basic settings for operating the DEEneo can be made using the SET button. Alternatively, these and other functions can be configured using the **eddySetup** software.

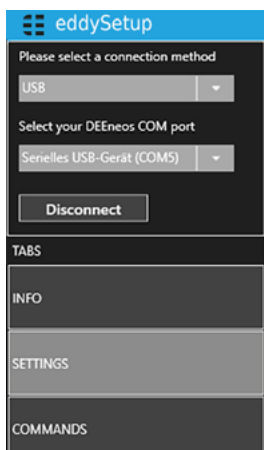

Functions:

- Sensor supply: Frequency, amplitude
- Configuration of switching output: activated, deactivated, set limit value (threshold), hysteresis
- Output signal selection
- Conversion of alarm output S2 to second switching output
- Filter corner frequency
- Restore factory settings
- Teach function
- Activation of alarm output

System requirements:

- Windows 10
- Windows 11

ORDER CODE

DEEneo – **X**
a

a Output signal

020A	=	0...20 mA
420A	=	4...20 mA
10V	=	0...10 V
5V	=	0...5 V
±5V	=	-5...5 V
±10V	=	-10...10 V

S1+DEEneo

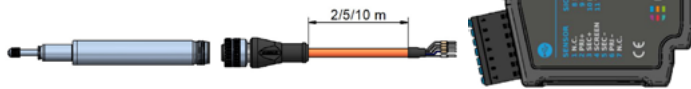

S2+DEEneo

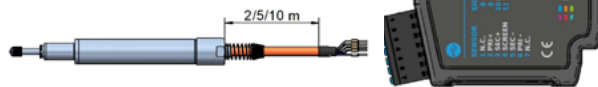

■ Possible combinations:

- S1+DEEneo: Sensor with connector output, cable K4PxM, electronics DEEneo
- S2+DEEneo: Sensor with cable output, electronics DEEneo