



SM SERIES | LVDT

Inductive Position Transducer: Standard series that fits nearly all industrial and laboratory applications, highly customisable

- High precision and linearity
- Various configuration options
- Push-rod guided and unguided, spring loaded
- Stainless steel housing
- Linearity up to 0,10 %
- Measuring range 2...200 mm

LVDTs (Linear Variable Differential Transformers) are inductive sensors excellent for use in harsh industrial environments, e.g. high temperature and pressure ranges, as well as high accelerations and measuring cycles.

The SM series offers ultimate reliability and precision in a small size, and is designed for industrial and lab use. With a measuring range from 2 up to 200 mm and various configuration options (mechanics, protection class, temperature range, linearity) the SM series ensures to have a suitable measuring system for every application.

TECHNICAL DATA - SENSORS

SENSOR							
Measurement range FS [mm]	0...2	0...5	0...10	0...25	0...50	0...100	0...200
Linearity [% of FS]	0.30 % (0.20 % optional, 0.10 % for selected models)						
Types	spring loaded (up to range 0...100 mm), free core, push rod guided/unguided						
Protection class	IP67, optional IP68						
Vibration stability DIN IEC68T2-6	10 G						
Shock stability DIN IEC68T2-27	200 G/2 ms						
Supply voltage/ frequency	3 V _{eff} /3 kHz						
Supply frequency	2...10 kHz						
Temperature range	-40...+120 °C (150 °C optional, option H, 200 °C on request)						
Mounting	ø 8 mm h6 clamp diameter or ø 12 mm						
Housing	stainless steel						
Connection	cable output or M12-connector with coupling nut						
cable TPE (standard)	ø 4.5 mm, 0.14 mm ² , non-halogen, suitable for drag chains						
PTFE (option H)	ø 4.8 mm, 0.24 mm ² , max. temperature 200 °C, UL Style 2895						
Max. cable length	100 m between sensor and electronics						
Spring loaded version (up to range 100 mm)							
Spring force (middle of range) [N]	0.9	0.9	0.9	0.95	0.95	1.50	-
Max. cycles of tip at 1 mm amplitude [Hz]	55	50	50	35	20	15	-
Life cycle	> 10 million cycles						
Free core/ push rod/ push rod guided							
Max. acceleration of core/ push rod	100 G						
Life cycle	infinite						
Weight (approx., without cable) [g]	36	42	47	59	85	136	238

Note: A measuring amplifier is required for the operation of LVDT sensors. Eddylab offers various electronics, see page 5 or separate data sheets at www.eddylab.com. The electronics take over the sensor supply and convert the sensor signal into a standardized, analogue output signal with the help of a micro-controller. They also score points with simple adjustment (teach function) and linearization of the sensor characteristic curve to achieve the highest possible precision.

CABLE/PIN ASSIGNMENT (AC OUTPUT)

FUNCTION	WIRE COLOUR OF EDDYLAB CABLES		M12 CONNECTOR
	TPE CABLE	PTFE-UL CABLE	PIN
Primary +	white	white	2
Primary -	brown	yellow	1
Secondary 1	blue	brown	3
Secondary 2	black	green	4

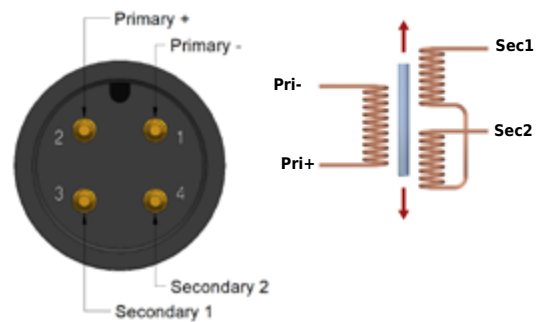

TECHNICAL DIMENSIONS

RANGE* (FS) [MM]	BODY LENGTH B RADIAL CABLE / CONNECTOR [MM]	BODY LENGTH C CONNECTOR M12 [MM]	CORE LENGTH D [MM]	PUSH ROD LENGTH E [MM]
0...2	64	67	22	54
0...5	70	73	25	60
0...10	80	83	30	70
0...25	110	113	45	100
0...50	160	163	70	150
0...100	260	263	120	250
0...200	460	463	220	450

* Other measurement ranges are available on request.

■ TYPE: FREE CORE (D), PUSH ROD UNGUIDED (E)

Free Core (D): Delivery: core (the core extension made of non-magnetic material must be added by the customer).

Push rod unguided (E): delivery: core + core extension

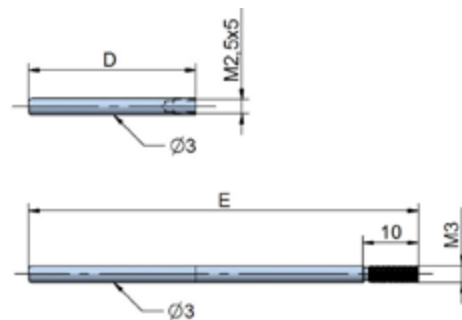
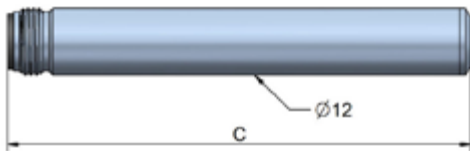

■ TYPE: PUSH ROD GUIDED

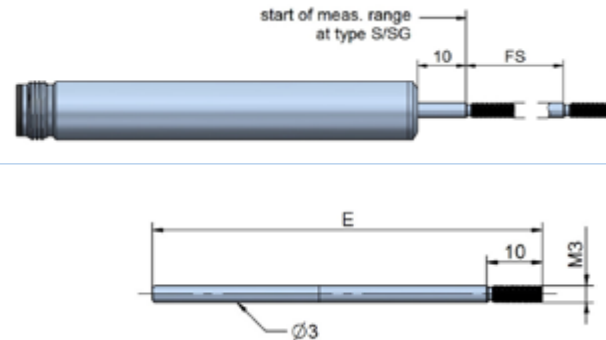
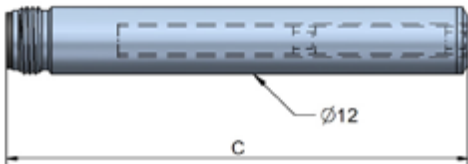

■ TYPE: SPRING LOADED (UP TO RANGE 0...100 MM)

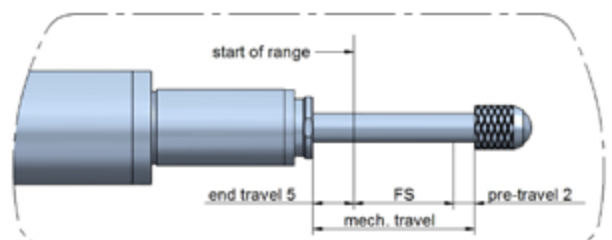
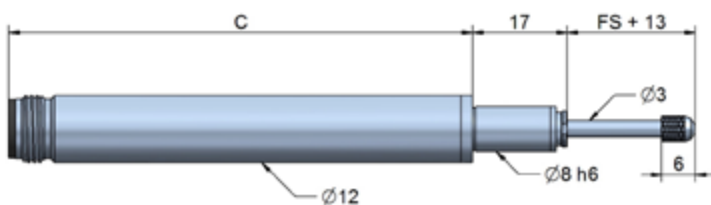

Please note that the stated end travel and start travel (see detailed picture) are standard values. When calibrating the sensors we are aiming for best linearity.

SENSOR TYPES

CONNECTOR / CABLE OUTPUT AXIAL / RADIAL

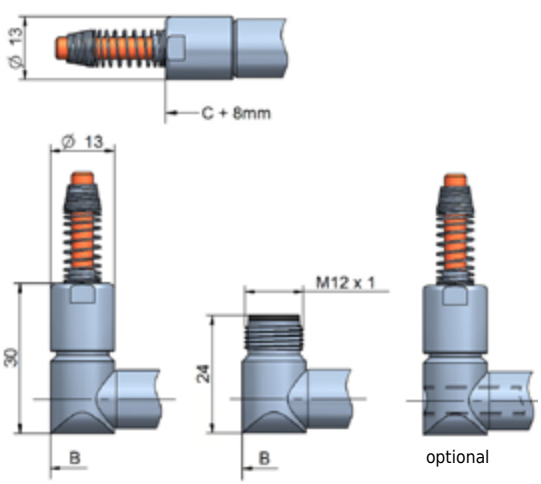

Sensors with cable output have a cable fitting and a spring for bend protection of the cable. For installation, the bending radius should not be less than 3 times the cable diameter. The standard cable length is 2 m.

Instruments with option H for temperatures up to 150 °C/ 200°C feature a PTFE cable.

For normal application the sensors have a closed rear end body.

Sensors that feature a radial cable output can be supplied with a through hole on request. Please use this version for applications at heavy dirt exposure. The movement of the push rod removes dirt from the sensor and conveys it to the rear.

CONNECTOR OUTPUT (CABLE WITH STRAIGHT OR ANGULAR CONNECTOR)

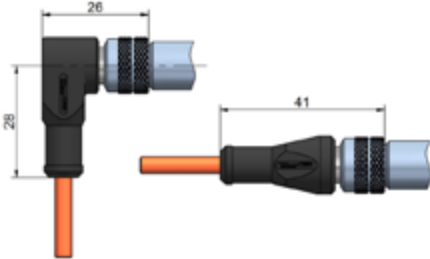

For sensors with connector output the cable has to be ordered separately. You can choose from a cable with a straight connector or with an angular connector.

The connector is protected from accidental removal by a threaded fitting (M12). The cable lengths are 2/ 5/ 10 m.

The connector pair has protection class IP67.

The total length of the sensor with connector is:

- body length of the connector M12 (see table) + 20 mm (angular connector)
- body length of the connector M12 (see table) + 37 mm (straight connector)

GAITER (OPTION FB FOR SM2...SM25)

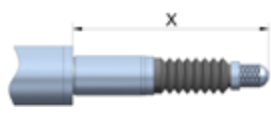

A gaiter is available for spring loaded sensors to protect the mechanics from fouling. Note: The gaiter is also available as retrofit kit for measurement ranges from 2 to 25 mm. The working temperature is limited to 0...+120 °C.

X	START OF MEASURING RANGE (0 V / 4 MA)	END OF MEASURING RANGE (10 V / 20 MA)	FULLY EXTENDED
SM2-T	28 mm	30 mm	32 mm
SM5-T	28 mm	33 mm	35 mm
SM10-T	28 mm	38 mm	40 mm
SM25-T	35 mm	60 mm	62 mm

ROD SEAL / WIPER (OPTION W)

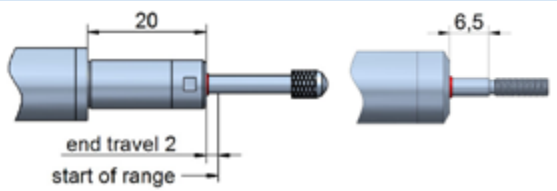

A special design of a fluorocarbon sealing is integrated in the sensor front cap. It combines sealing and wiping and ensures a smooth motion of the mechanics.

Note: The end travel is reduced

- from 5 mm to 2 mm for spring loaded sensors
- from 10 mm to 6,5 mm for guided push rod (SG) types

DEEneo | DEEneo-ISC

The **DEEneo** signal conditioner was developed for operating inductive LVDT sensors (full bridge). The electronics supply the sensor and convert the sensor signal into a standardized, analogue output signal with the help of a microcontroller. A push button (SET button) is used for the basic configuration and to set the measuring range limits - this enables quick and easy adaptation to the customer's application. Where possible, eddyLab calibrates the sensor and electronics together. The sensor characteristic curve can be linearized to meet the highest demands on the accuracy of the measuring chain. Further features can be configured via the **eddySetup** configuration software. Further information can be found in the [DEEneo](#) and [DEEneo-ISC](#) data sheets.

■ DEEneo*

Digital signal converter for DIN rail mounting

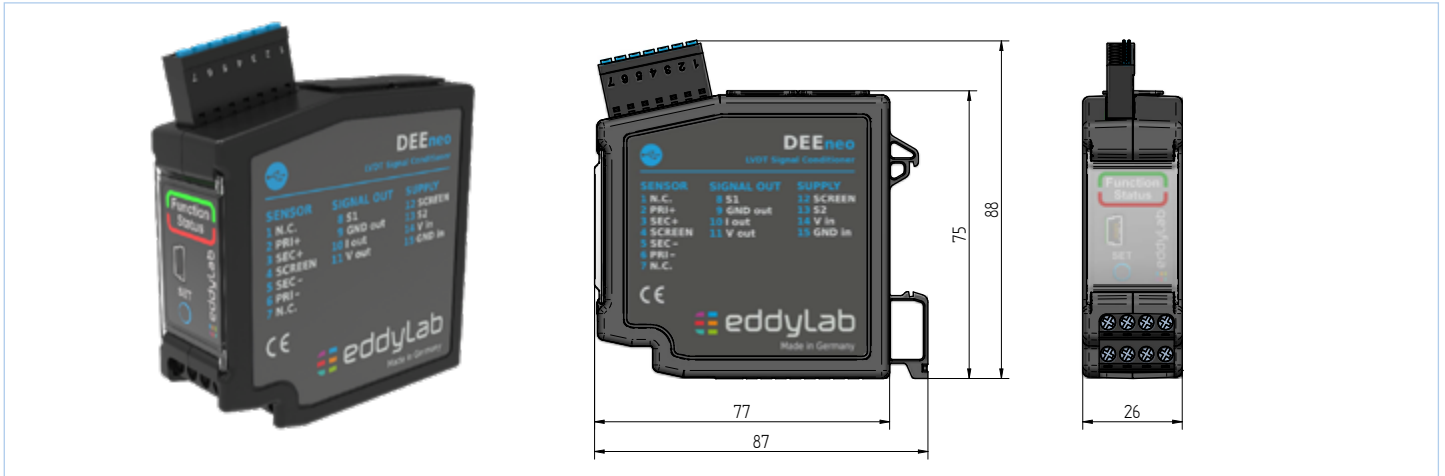

■ DEEneo-ISC*

Inline Signal Conditioner (cable electronics)

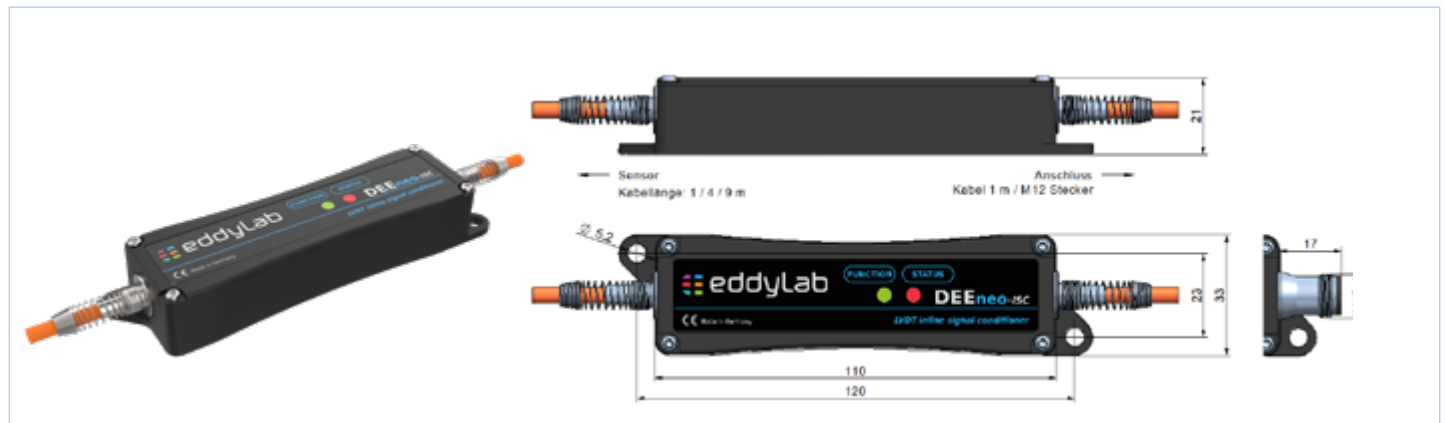

TECHNICAL DATA

ELECTRONICS	DEEneo*	DEEneo-ISC*
Output signal	0...20 mA, 4...20 mA (Last < 300 Ohm)	
	0...5 V, ± 5 V; 0...10 V, ± 10 V	
Mounting	on 35 mm DIN rail in accordance with DIN EN 60715	integrated in sensor cable
Power supply	9...36 VDC	
Power consumption	70 mA at 24 VDC, 130 mA at 12 VDC	
Sensor supply	standard: 3V / 3.3 kHz, can be modified by software	
Settings (factory setting)	frequency, amplitude, output signal	
Resolution	16 bit	
Signal processing	digital via microcontroller	
Signal adjustment	via SET-button or software	
Linearisation of sensor	yes, optionally possible	
Features		
Switching output	open drain up to 60 V, max. 115 mA	-
Alarm output	open drain up to 60 V, max. 115 mA	-
Cable break detection	yes	

*Separate data sheets for DEEneo and DEEneo-ISC at www.eddylab.com

ACCESSORIES

■ CONNECTION CABLE (SHIELDED) FOR CONNECTOR OUTPUT

CABLE M12 ANGULAR CONNECTOR		CABLE M12 WITH STRAIGHT CONNECTOR	
K4P2M-SW-M12	2 m	K4P2M-S-M12	2 m
K4P5M-SW-M12	5 m	K4P5M-S-M12	5 m
K4P10M-SW-M12	10 m	K4P10M-S-M12	10 m
K4P15M-SW-M12	15 m	K4P15M-S-M12	15 m
K4P20M-SW-M12	20 m	K4P20M-S-M12	20 m
K4P50M-SW-M12	50 m	K4P50M-S-M12	50 m



■ MATING CONNECTOR M12 FOR SELF ASSEMBLY (SHIELDED)

	STRAIGHT CONNECTOR D4-G-M12-S	ANGULAR CONNECTOR D4-W-M12-S
Protection class	IP67	
Temperature range	-25...+90 °C	
Mode of connection	spring closure construction	
Cable diameter	ø 4...8 mm	
Conductor	0,14...0,34 mm ²	



■ FEELER FOR SPRING LOADED VERSION

MATERIAL OF TASTKOPF-01 FEELER BALLS

steel: for standard applications

ruby: much harder and wear resistant than steel, non-conductive, for all applications except for measuring on aluminium and cast iron

ceramics: comparable to ruby, best choice for measuring on aluminium and cast iron

- Tastkopf-01, steel (standard)
- Tastkopf-01-HM, cemented carbide
- Tastkopf-01-R, ruby
- Tastkopf-01-K, ceramics

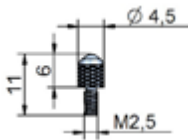

- Tastkopf-02, steel
- Tastkopf-02-HM, cemented carbide

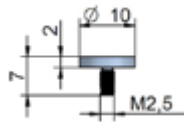

- Tastkopf-03, steel
- Tastkopf-03-HM, cemented carbide

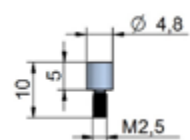

- Tastkopf-04, steel

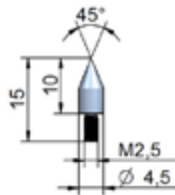

- Tastkopf-05, steel

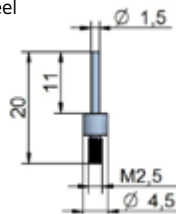

- Tastkopf-782.238, roller

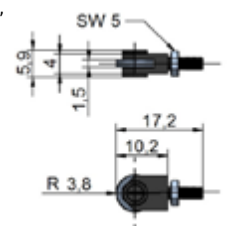

■ RETROFIT GAITER INCL. SECURING RINGS

for SM2	Set-FB-2
for SM5	Set-FB-5
for SM10	Set-FB-10
for SM25	Set-FB-25



ACCESSORIES

■ MOUNTING PARTS

Flanschklemmstück 8-AL, flange clamp $\varnothing 8$ mm

Material: aluminum, temperature resistant up to 120 °C

Flanschklemmstück 8-VA, flange clamp $\varnothing 8$ mm

Material: stainless steel, temperature resistant up to 200 °C

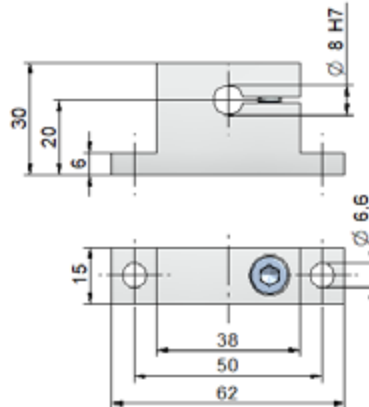

Flanschklemmstück 12-PA, flange clamp 12-PA

Material: Polyamide, reinforced temperature resistant up to 100 °C

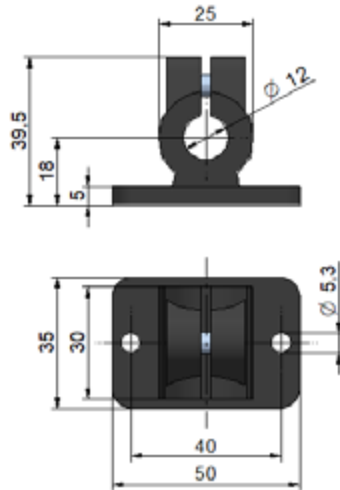

Flanschklemmstück 12-VA, flange clamp 12-VA

Material: stainless steel temperature resistant up to 200 °C

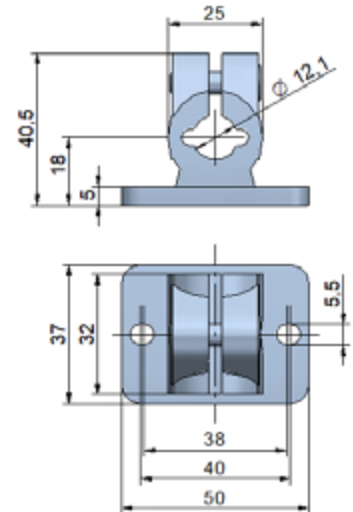

Fußklemmstück 12-PA, base clamp 12-PA

Material: Polyamide, reinforced temperature resistant up to 100 °C

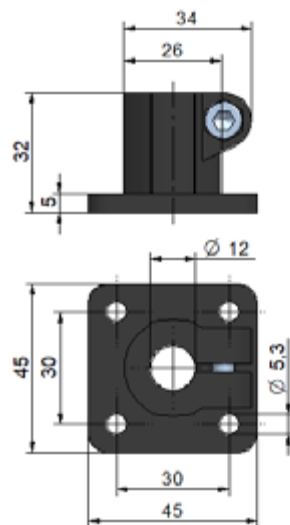

Fußklemmstück 12-VA, base clamp 12-VA

Material: stainless steel temperature resistant up to 200 °C

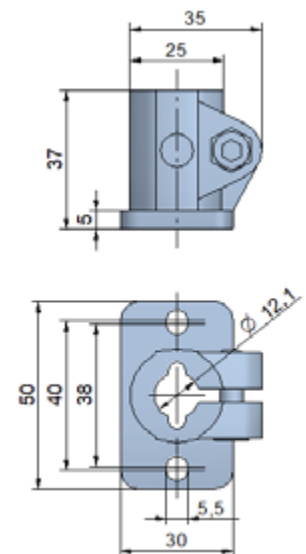

ORDER CODE SENSOR

SM **X** - **X** - **X** - **X** **X** **X** **X** **X** **X** **X** **X**

a **b** **c** **d** **e** **f** **g** **h** **i** **j**

a measurement ranges [mm]

2 / 5 / 10 / 25 /
50 / 100 / 200

b type

A = free core
S = unguided push rod
SG = guided push rod
T = spring loaded

c cable/ connector

KA = axial cable output
KR = radial cable output
SA = axial connector output M12
SR = radial connector output M12

d cable / connector output

S1: sensor with connector output

1 = connector output M12 (no cable)

S2: sensor with cable output, open cable end for DEEneo

A = TPE cable 2 m
B = TPE cable 5 m
C = TPE cable 10 m
D = PTFE-UL cable 2 m (option H)
E = PTFE-UL cable 5 m (option H)
F = PTFE-UL cable 10 m (option H)

S3: sensor with cable output for DEEneo-ISC

G = TPE cable 2 m
H = TPE cable 5 m
J = TPE cable 10 m
K = PTFE-UL cable 2 m (option H)
L = PTFE-UL cable 5 m (option H)
M = PTFE-UL cable 10 m (option H)

e linearity

1 = 0,30 % (standard)
2 = 0,20 % (option L20)
3 = 0,10 % (option L10)

f temperature range

1 = -40...+120 °C (standard)
2 = -40...+150 °C (option H)
3 = -40...+200 °C (option H200)

g push rod sealing

1 = - (standard)
2 = gaiter (option FB)
3 = wiper ring (option W)

h protection class

1 = IP67
2 = IP68 (option IP68)

i housing

1 = stainless steel

j spring force

1 = for type „A/S/SG“
2 = standard
3 = HD2.5 (approx. 250g)
4 = HD (approx. 500g)

ORDER CODE ELECTRONICS

DEEneo - **X**

a

DEEneo-ISC - **X** - **X**

a **b**

type

DEEneo = external electronics
DEEneo-ISC = cable electronics

a output signal

020A = 0...20 mA
420A = 4...20 mA
10V = 0...10 V
5V = 0...5 V
±5V = -5...5 V
±10V = -10...10 V

b type of cable / length

E1: for sensor with cable output

- = integrated in sensor cable

E2: for sensor with connector output

A = cable 2 m, M12 straight female conn.
B = cable 2 m, M12 angular female conn.
C = cable 5 m, M12 straight female conn.
D = cable 5 m, M12 angular female conn.
E = cable 10 m, M12 straight female conn.
F = cable 10 m, M12 angular female conn.

b type of cable / length

E3: for sensor with cable output

M12 = integrated in sensor cable, M12 connector

E4: for sensor with connector output

M12A = cable 2 m, M12 straight female conn., M12 conn.
M12B = cable 2 m, M12 angular female conn., M12 conn.
M12C = cable 5 m, M12 straight female conn., M12 conn.
M12D = cable 5 m, M12 angular female conn., M12 conn.
M12E = cable 10 m, M12 straight female conn., M12 conn.
M12F = cable 10 m, M12 angular female conn., M12 conn.

possible combinations:

- S3+E1: sensor with cable output, DEEneo-ISC integrated in sensor cable
- S3+E3: sensor with cable output, DEEneo-ISC integrated in sensor cable, M12 connector
- S1+E2: sensor with connector output, DEEneo-ISC with cable K4PxM
- S1+E4: sensor with connector output, DEEneo-ISC with cable K4PxM, M12 connector
- S1+DEEneo: sensor with connector output, cable K4PxM, DEEneo
- S2+DEEneo: sensor with cable output, DEEneo

