



GENERAL FEATURES

- 0...1200 mm stroke (measuring) length
- High resolution
- ± 0.25 FS linearity
- Analog or CANopen interface
- Thanks to the teach-in feature, the minimum and maximum measurement limits can be adjusted on the sensor
- IP67 protection class
- 2 m/s maximum speed
- Shock/vibration resistant
- Robust aluminum housing and stainless steel measuring wire
- Compact design

AWP 110 HR series high resolution draw wire sensors work as absolute. They make measurement by pulling and rewinding stainless steel wire. They have 0...1200 mm stroke (measuring) length. They convert linear motion to analog or CANopen output. Thanks to its high IP67 protection class, they can work in harsh ambient conditions.

MECHANICAL DATA

Stroke (measuring) Length	0...1200 mm
Required Force	5 N
Max Speed	2 m/s
Linearity	± 0.25 FS
Weight	≈ 460 gr
Protection Class	IP67
Operating Temperature	-20°C ... +85 °C
Relative Humidity	%10 ... %90
Material	Body: Aluminum
	Measuring Wire: Stainless Steel

MECHANICAL DIMENSIONS (mm)

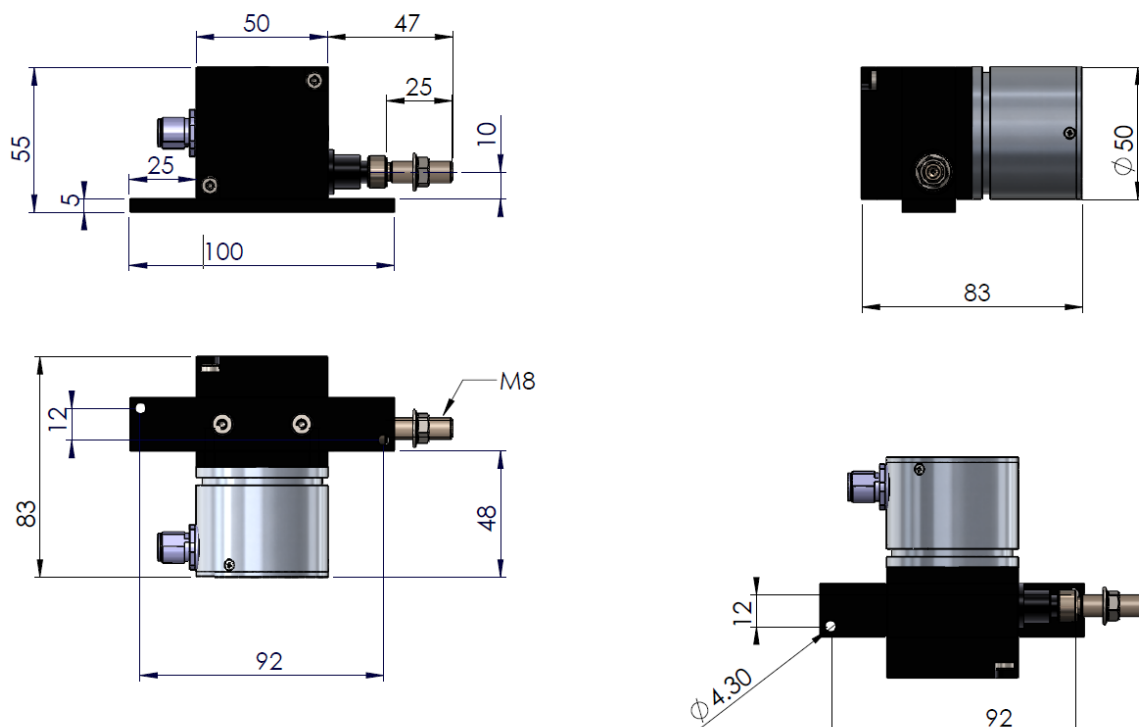

ANALOG VERSION

Electrical Features

Measuring Range	0...1200 mm
Working Principle	Hall Effect
Output Signal	Voltage: 0-10V, 0.5-4.5V, 0-5V Current: 4-20 mA
Signal characteristics	Increasing (exmp: 4-20 mA) Decreasing (exmp:20-4 mA)
Supply Voltage	15 ... 26 VDC
Current Consumption	≤60 mA
Output load	For current output; min 250 Ω For voltage output; min 1 kΩ
Resolution	16 bit
Response Frequency	500 Hz
Reverse Polarity Protection	Yes
Short circuit protection	Yes (only supply)
Electrical Connection	M12 / 5 pin male connector

Electrical Connection

Signal	Cable	M12 5 Pin Male Connector
V+ (15...26 VDC)	Red	Pin 1
Analog output signal	Yellow	Pin 2
GND	Black	Pin 3
N/C	Green	Pin 4
N/C	Pink	Pin 5

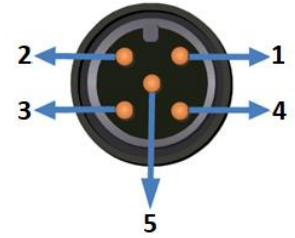

Sipariş Kodu

Model			Electrical Connection			
AWP 110HR	-	XXXX	-	XXXX	-	XX
Stroke (Measuring) Length			Analog Output Signal			
Different stroke lengths from 0 to 1200 mm			V : 0-10 VDC V1 : 0-5 VDC A : 4-20 mA V3 : 0.5-4.5 VDC NV : 10-0 VDC NV1 : 5-0 VDC NA : 20-4 mA NV3 : 4.5-0.5 VDC			

ANALOG VERSION, PROGRAMMABLE

Electrical Features

Measuring Range	0...1200 mm
Working Principle	Hall Effect
Output Signal	Voltage: 0-10V, 0.5-4.5V, 0-5V (programmable) Current: 4-20 mA (programmable)
Signal characteristics	Increasing (exmp: 4-20 mA) Decreasing (exmp:20-4 mA)
Supply Voltage	15 ... 26 VDC
Current Consumption	≤60 mA
Output load	For current output; min 250 Ω For voltage output; min 1 KΩ
Resolution	16 bit
Response Frequency	500 Hz
Reverse Polarity Protection	Yes
Short circuit protection	Yes (only supply)
Electrical Connection	M12 / 5 pin male connector

Electrical Connection

Signal	Cable	M12 5 Pin Male Connector
V+ (15...26 VDC)	Red	Pin 1
Analog output signal	Yellow	Pin 2
GND	Black	Pin3
N/C	Green	Pin 4
SPAN/ZERO	Pink	Pin 5

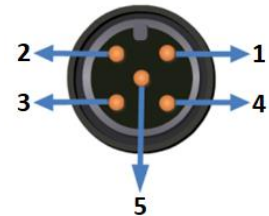

SETTING MEASUREMENT LIMITS: With this feature, you can set the minimum and maximum measurement limits.

In order to determine the **minimum measurement limit (lim1)**, the SPAN/ZERO and GND terminal are short-circuited for at least 3 seconds.

In order to determine the **maximum measurement limit (lim2)**, the SPAN/ZERO and GND terminal are short-circuited for at least 6 seconds.

To **return to the factory settings**, the SPAN/ZERO and GND terminal are short-circuited for at least 10 seconds.

SAMPLE SIGNAL OUTPUT GRAPHICS

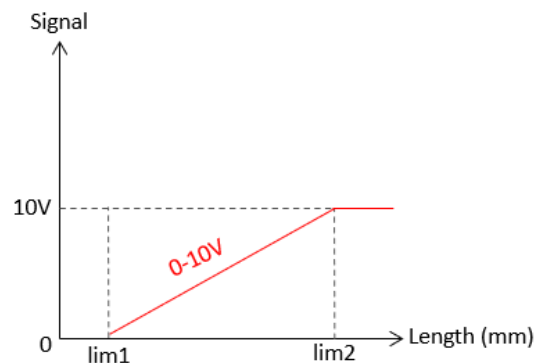
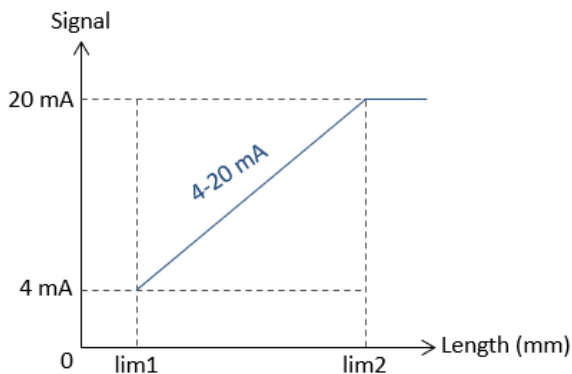

Order Code

Model	Electrical Connection	Programming Feature
AWP 110HR - XXXX - XXXX - XX - XX	S13M : M12 5 pin male connector	PL: Programmable
Stroke (Measuring) Length Different stroke lengths from 0 to 1200 mm	Analog Output Signal V: 0-10 VDC V1: 0-5 VDC A: 4-20 mA V3: 0.5-4.5 VDC NV: 10-0 VDC NV1: 5-0 VDC NA: 20-4 mA NV3: 4.5-0.5 VDC	

CANopen VERSION

Electrical Features

Measuring Range	0...1200 mm
Working Principle	Hall Effect
Supply voltage	12...30 VDC
Current consumption	≤60 mA
Reverse polarity protection	Yes
Short circuit protection	Yes (only supply)
Response frequency	500 Hz
Resolution	6µm
Electrical connection	M12 5 pin male connector

CANopen Features

Communication Profile	CiA 301
Device Type	CANopen, CiA DS406
Node ID	Adjustable from 1 to 127 with LSS or SDO
Baud Rate	10 kBit/s, 20 kBit/s, 50 kBit/s, 100 kBit/s, 125 kBit/s, 250 kBit/s, 500 kBit/s, 800 kBit/s, 1 Mbit/s
PDO Data Rate	100 ms
Error Control	Heartbeat, Emergency Message
PDO	3 Tx PDO
PDO Modes	Event/Time triggered, Synch/Asynch
SDO	1 server
Position Information	Object Dictionary 0x6020
Termination Resistance	Optional 120Ω

Electrical Connection

Signal	Cable	M12/ 5 Pin Male Connector
CAN_SHIELD	CAN SHIELD	Pin 1
V+ (12...30VDC)	Red	Pin 2
GND (0V)	Black	Pin 3
CAN_H	Yellow	Pin 4
CAN_L	Green	Pin 5

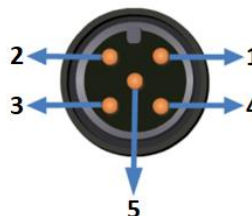

Order Code

Model		Electrical Connection			
AWP 110HR	-	XXXX	-	XXXX	- X
Stroke (Measuring) Length			Output Signal		
Different stroke lengths from 0 to 1200 mm			C : CANopen		

MOUNTING AND WARNINGS

1. Never release the wire after pulling. Otherwise, the coil spring will be damaged.

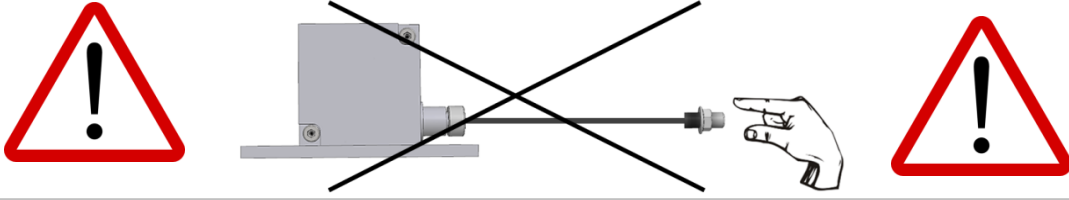

2. Mount the sensor according to the mounting directions shown below.

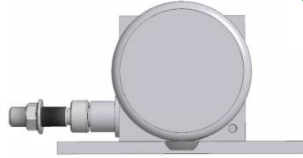

3. If there is a trickle of water (like a rain), the wire outlet must not be a drip of water upstream. If needed please use guide rollers.

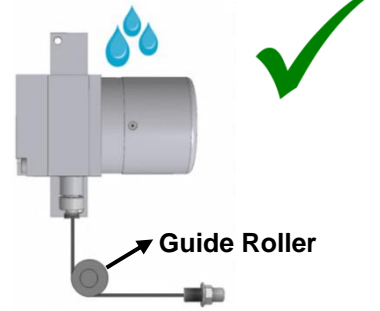
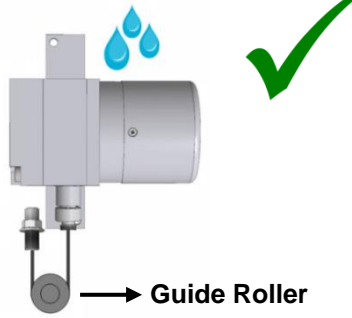

4. The wire should not be pulled in angular. If needed, please use guide rollers.

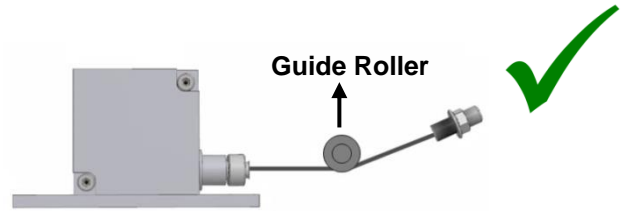
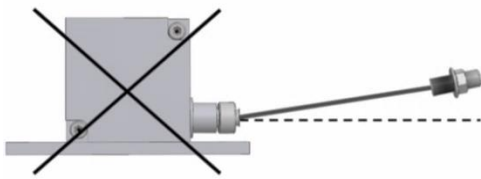

Important Note(!): Failure to comply with these recommendations, the malfunctions that may occur will not be under the warranty.

SAMPLE APPLICATION FIELDS

- Elevators
- Press machines
- Crane systems
- Wood processing machines
- Marble processing machines
- Storage positioning
- Sluice gate control
- Air compressors
- Glass processing machines
- Lifting platforms
- Applications in medical technologies
- Forklifts
- Screw machines
- Paper machines
- Sewing machines
- Hydraulic machines
- Sheet metal machines
- Printing machines
- Horizontal control equipments
- Construction machines
- Industrial robots
- Injection machines
- X-Y axis displacement
- Various otomation applications

Atek Elektronik Sensör Teknolojileri Sanayi ve Ticaret A.Ş.



Gebze OSB, 800. Sokak, No:814 Gebze/KOCAELI/TURKEY



Tel: +90 262 673 76 00



Fax: +90 262 673 76 08



www.ateksensor.com



info@ateksensor.com