

# ULTRASONIC SENSOR



## Content:

<b>Technical Data</b>	<b>....2</b>
<b>Technical Drawing</b>	<b>....2</b>
<b>Electrical connection</b>	<b>....3</b>
<b>Available outputs</b>	<b>....3</b>
<b>Response diagram</b>	<b>....3</b>
<b>Accessories</b>	<b>....4</b>
<b>Order code</b>	<b>....4</b>

## Series UPK

### Key-Features:

- Measurement range up to 1200 mm
- Output: PNP, NPN, 0...10 V or 4...20 mA
- Protection class: IP67
- Temperature range: -20 °C to +70 °C
- M18 Housing
- Versions with plastic or stainless steel housing

## TECHNICAL DATA

		UPK-300	UPK-800	UPK-1200
Measurement range	[mm]	40...300 *	60...800 *	80...1200 *
Beam angle	[°]	7 ± 2	8 ± 2	
Switching frequency	[Hz]	8	4	5
Power supply	[VDC]	10...30		
max. ripple content	[%]	5		
Linearity	[%]	1		
Repeatability	[%]	1		
Resolution	[mm]	2		
Output		Switching output: PNP or NPN (NO/NC changable via teach wire**) or Analog output: 0...10 V or 4...20 mA		
Output current	[mA]	100		
Output voltage drop		≤ 2.2 V at I = 100 mA		
Supply current (without load)		≤ 35 mA at Val = 30 V		
Leakage current		≤ 10 µA at 30 V		
Power-On delay	[ms]	≤ 100		
Temperature	[°C]	-20...+70		
Temperature drift of MR	[%]	≤ 5		
Short circuit protection		yes (auto-reset)		
Induction protection		yes		
Inverse-polarity protection		yes		
Weight		plastic version: with connector 65 g / with cable 75 g stainless steel version: with connector 80 g / with cable 140 g		
LEDs		yellow: output green: alignment		
Connection		connector M12 or cable 2 m		
Protection class		IP67		
EMC		IEC60947-5-2		
Housing		plastic version: PTB stainless steel version: V4A		
Membrane		epoxy-glass resin		

\* applies for metallic targets with a size of 100 x 100 mm (UPK-300) respectively 200 x 200 mm (UPK-800 and UPK-1200)

\*\* see „[Adjustment Option](#)“

## TECHNICAL DRAWING

Version with cable output

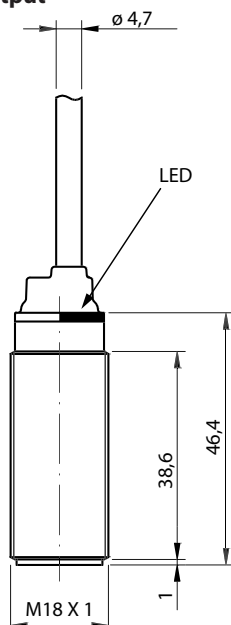

Version with connector output

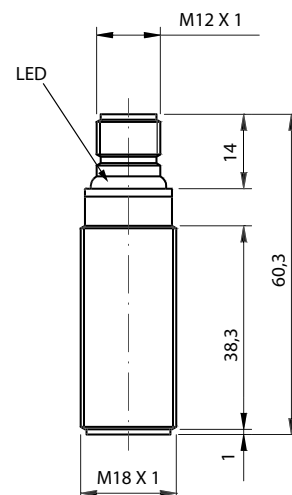

## ELECTRICAL CONNECTION

### Circuit diagram analog output

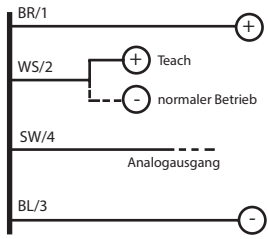

### Circuit diagram PNP output

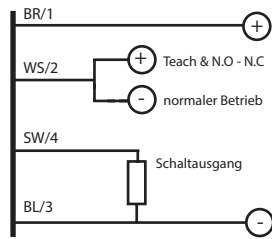

### Circuit diagram NPN output

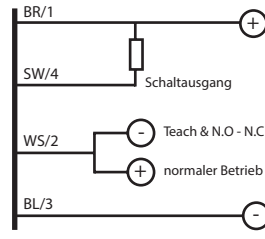

### Connector output, M12

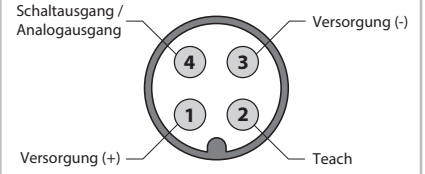

## AVAILABLE OUTPUTS

### Version with switching output

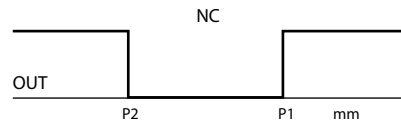
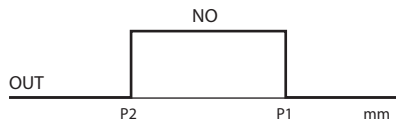

### Version with analog output

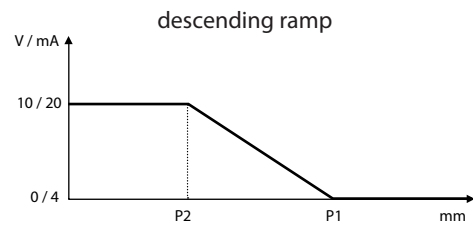
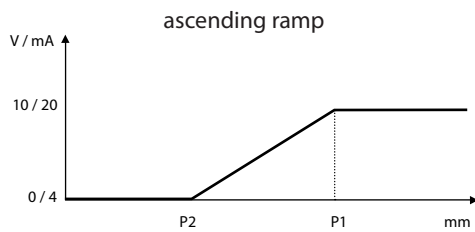

## RESPONSE DIAGRAMS

### UPK-300

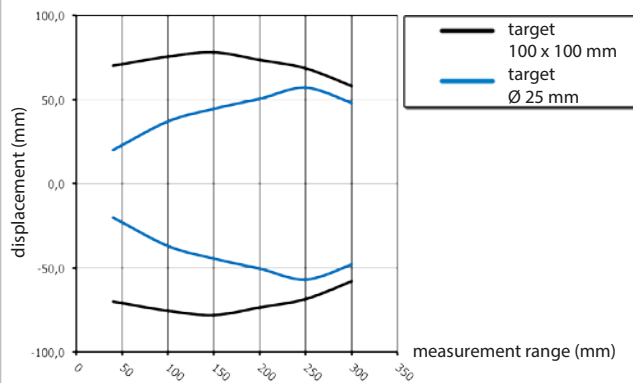

### UPK-800

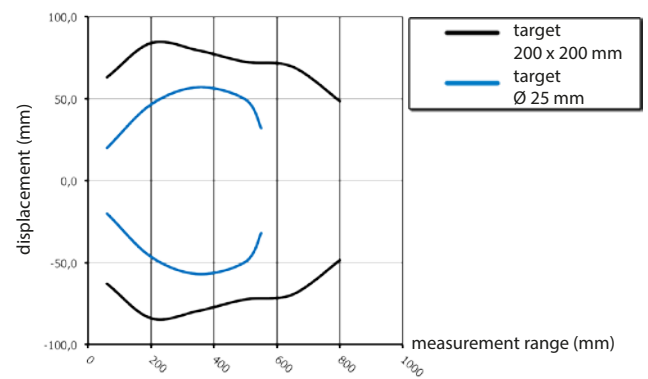

### UPK-1200

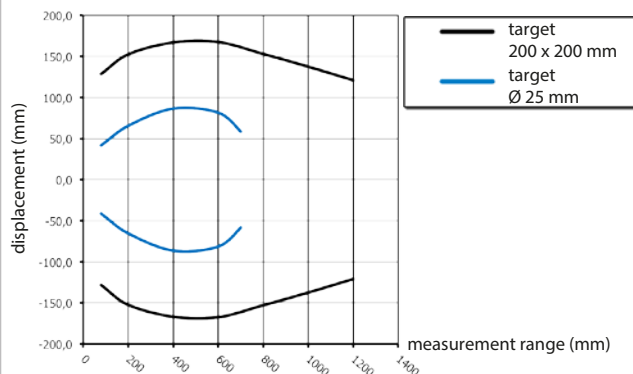

## ACCESSORIES

### Accessories plastic version

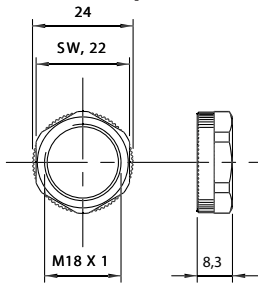

plastic clamping ring  
(2x included in delivery)

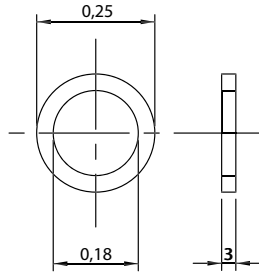

plastic washer  
(2x included in delivery)

### Accessories stainless steel version

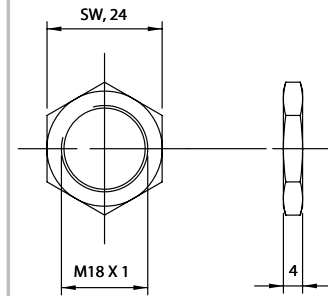

metallic clamping ring  
(2x included in delivery)

## ADJUSTMENT OPTION

### NO/NC selection (PNP and NPN versions only)

- Connect the teach wire to +V (PNP models) or to GND (NPN models) for a time of at least 8 s
- The yellow LED blinks quickly until the teach wire is released, then blinks 5 times to confirm the change from NO to NC respectively NC to NO.

## ORDER CODE

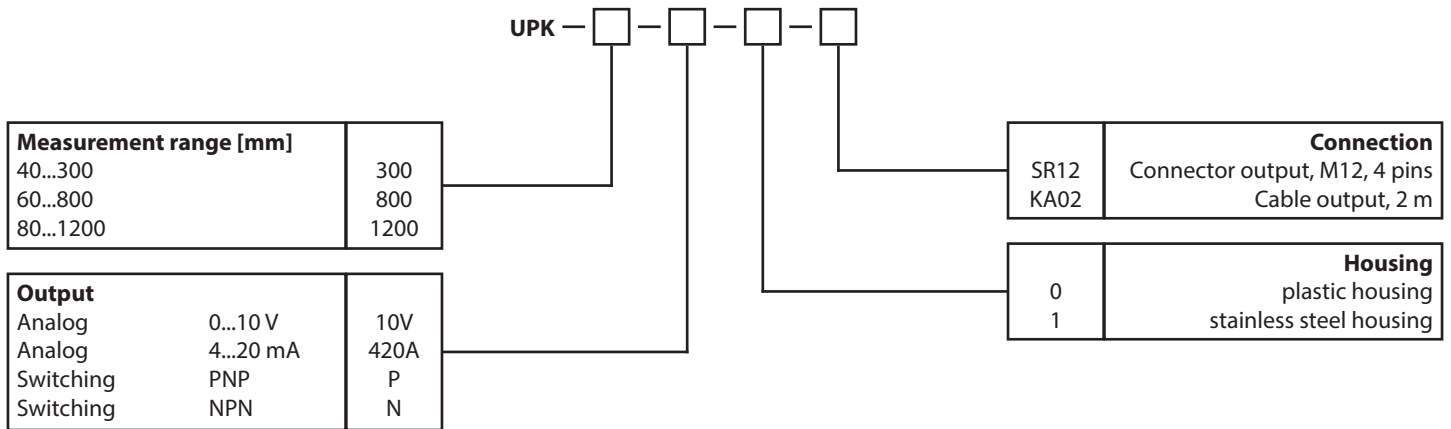

Subject to change without prior notice.

**WayCon Positionsmesstechnik GmbH**  
email: [info@waycon.de](mailto:info@waycon.de)  
internet: [www.waycon.biz](http://www.waycon.biz)

**WayCon**  
Positionsmesstechnik

**Head Office**  
Mehlbeerenstr. 4  
82024 Taufkirchen  
Tel. +49 (0)89 67 97 13-0  
Fax +49 (0)89 67 97 13-250

**Office Köln**  
Auf der Pehle 1  
50321 Brühl  
Tel. +49 (0)2232 56 79 44  
Fax +49 (0)2232 56 79 45