

EDDY CURRENT PROBES

Contact-free measurement on metal surfaces



Series IC

Key-Features:

- low-cost series with integrated Analog-Electronics
- different measurement ranges up to 8 mm
- Output signals 0..20 mA, 4..20 mA, 0..10 V
- Threaded housings M12, M18 and rectangular version
- Linearity up to $\pm 60 \mu\text{m}$
- Working temperature up to $-10...+70 \text{ }^\circ\text{C}$
- Measurement on all metal surfaces
- Protection class IP67

Content:

TECHNICAL DATA

Sensor		IC12-02	IC18-08	IC18-08-V	IC2035-03	IC2035-03-V
Measurement range	[mm]	0...2	0...8	0...8	2...5	2...5
Linearity	[μm]	± 60	± 400	± 400	± 100	± 100
Repeatability	[μm]	<5	<15	<15	<10	<10
Temperature drift*	[%]	± 2	± 5	± 5	± 4	± 4
Working temperature	[$^{\circ}\text{C}$]	0...+60	-10...+70	-10...+70	0...+60	0...+60
Supply Voltage V_s	[VDC]	15...30				
Max. power consumption	[mA]	50	40	20	35	20
Output signal		0...20 mA	4...20 mA	0...10 V	4...20 mA	1...9 V
Response time	[ms]	<2	<2	<2	<5	<5
Load resistance $V_s \text{ min}/V_s \text{ max}$	[Ω]	<100/ 400	<330/ 1000	>1000	<500/ 1000	>1000
Safety features		Reverse polarity / short circuit protection				
Housing material		95Mn28	nickel plated brass			
Housing design		M12 cylindric	M18 cylindric	M18 cylindric	rectangular	rectangular
Protection class		IP67				
Calibration material		S235 (ST37), ST52, 16MnCr5 / not suitable for aluminium and non-ferrous metals				

* based on full scale

TECHNICAL DRAWING

IC12-02

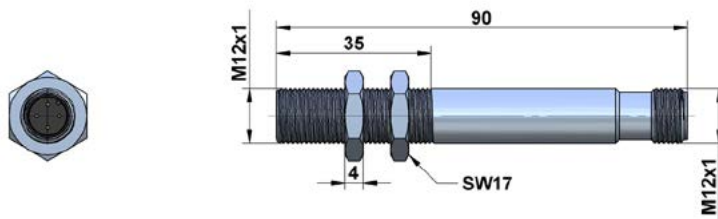

IC18-08, IC18-08-V

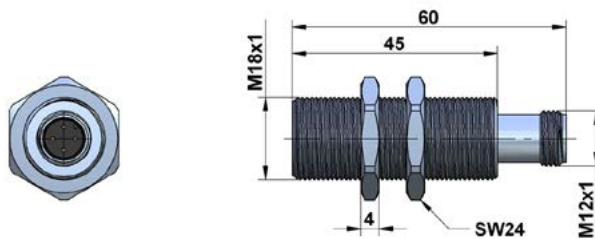

IC2035-03, IC2035-03-V

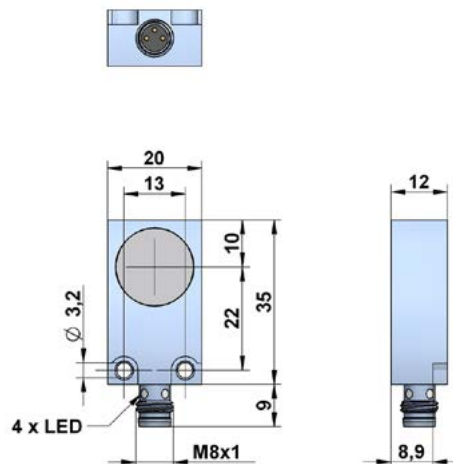

DIAGRAMS

Sensor: IC2035-03

Targets: St37; ST52; 16MnCr

Linearity Deviation [% of MR]

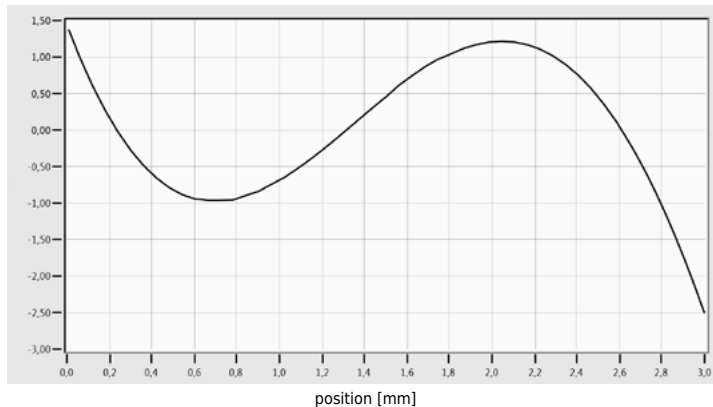

Sensor: IC12-02

Targets: St37; ST52; 16MnCr

Linearity Deviation [% of MR]

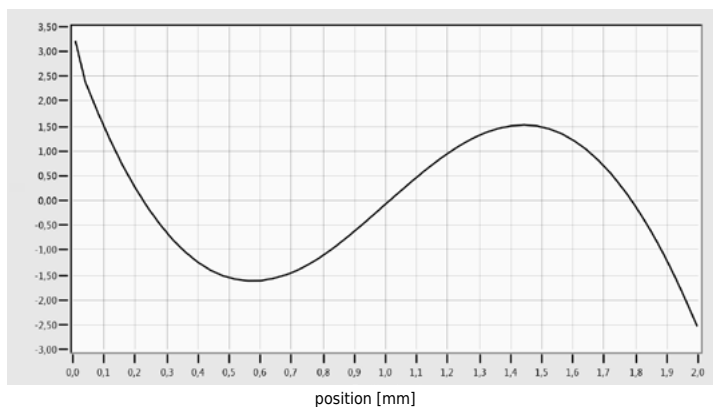

Sensor: IC18-08

Targets: St37; ST52; 16MnCr

Linearity Deviation [% of MR]

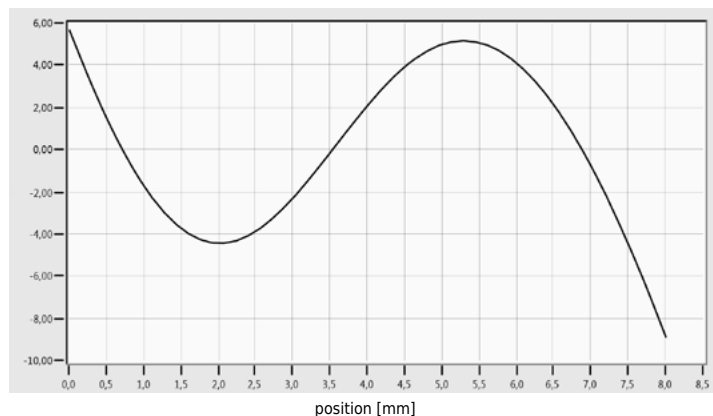

ELECTRICAL CONNECTION

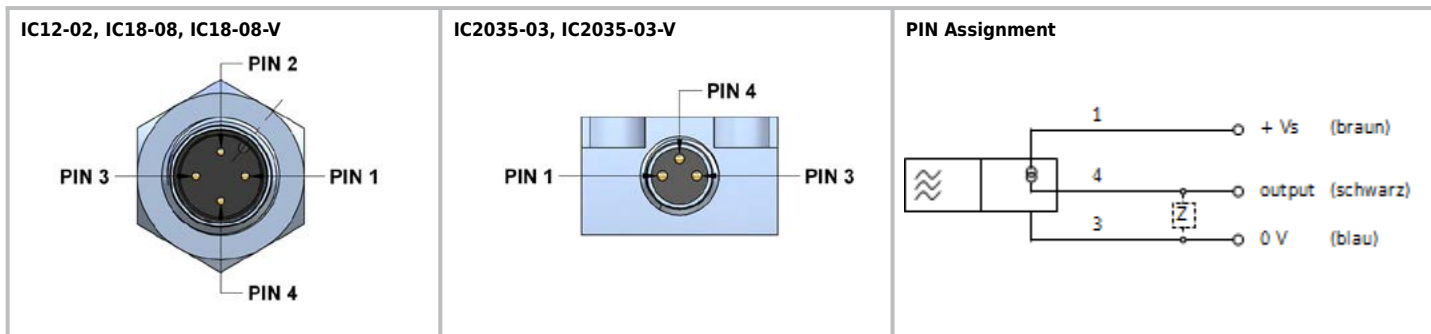

ORDER CODE

IC12-02

IC18-08

IC18-08-V

IC2035-03

IC2035-03-V

ACCESSORIES

Connection cable, 4 pole for IC12-02 and IC18-08

K4P2M-S-M12	2 m, straight connector, M12
K4P5M-S-M12	5 m, straight connector, M12
K4P10M-S-M12	10 m, straight connector, M12
K4P2M-SW-M12	2 m, angular connector, M12
K4P5M-SW-M12	5 m, angular connector, M12
K4P10M-SW-M12	10 m, angular connector, M12

Connection cable 3 pole for IC2035

K3P2M-S-M8	2 m, straight connector, M8
K3P5M-S-M8	5 m, straight connector, M8
K3P10M-S-M8	10 m, straight connector, M8

Subject to change without prior notice.