

# HIGH RESOLUTION ANALOGUE EDDY CURRENT SENSORS

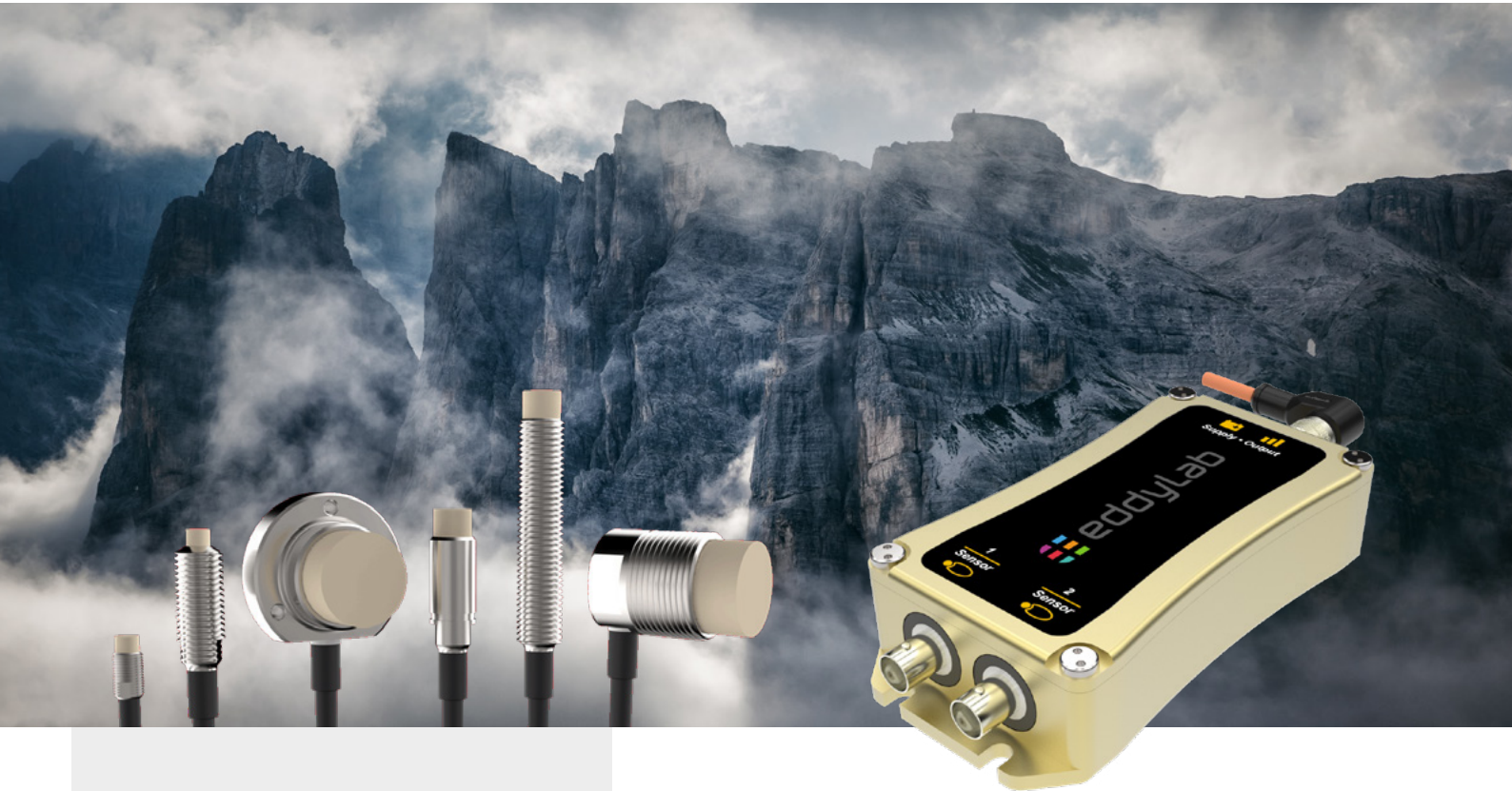

## AX Series

### Key-Features:

- 1 and 2 channel drivers
- Sensor protection class IP68
- Driver protection class IP40/IP68
- High resolution
- Analogue output
- Low current consumption
- High dynamics
- High noise immunity

### Content:

## INTRODUCTION

For more than fifteen years we have been occupied with the development and production of high-quality eddy current probes and drivers for industry and research. The AX driver series offers precise and high-resolution eddy current measurements with analogue output.

Eddy current probes are particularly suitable devices for non-contact measurements on metallic targets. Typical applications are measurements on rotating shafts for the detection of imbalance, vibration, out-of-roundness, air gap, radial/axial run-out, and much more besides. The extremely high resolution up to level of 20nm enables the smallest of amplitudes to be detected. eddylab probes are designed for temperatures up to 185 °C and are optimised for the entire temperature range with regard to temperature drift.

### The basic principle

The principle of measurement bases on an oscillating circuit made up of the probe (inductance) and a interconnect capacitance. This circuitry is attenuated in the presence of metallic objects. The oscillating circuit generates magnetic field lines - these induce eddy currents on the surface of conductive objects. The eddy currents counteract their cause and attenuate the amplitude of the oscillating circuit. This effect is decoupled from the oscillating circuit a fed towards further signal processing.

### AX Eddy Current Probe Driver

Probe Driver and Sensor are matched pairs. Every Sensor and Probe Driver will become a separate calibration certificate. A simple exchange of the Sensor is not possible without prior adjustment and recalibration.

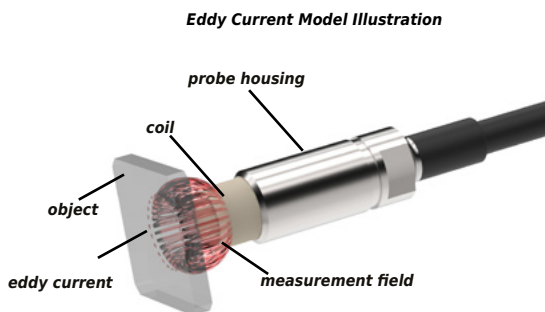

## TECHNICAL DATA – PROBES



Probe	T05	T2	T3	T4	T5	T10
range [mm]	0...0,5	0...2	0...3	0...4	0...5	0...10
offset gap (blind range)	~ 0.01 mm					
linearity	please refer to the technical data of the driver					
resolution reg. corner frequency [% FS]*	valid for middle of range					
10 kHz	0,075	0,061	0,040	0,033	0,047	0,045
temperature range sensor	-60...185 °C					
temperature coefficient sensor	0,2		0,05			
sensor cable PTFE-COAX	ø1,8 mm		ø2,5 mm (max. 2,7 mm)			
cable length	3 m					
min. bend radius static/dynamic	10/25 mm			15/37 mm		
temperature range cable	-55...+200 °C					
connection	BNC connector / optional LEMO connector					
protection class	IP68					
vibration	20 g, DIN EN 60068-2-6					
shock	100 g / 6 ms, DIN EN 60068-2-27					
check resistance [Ω]	6	8	9	12	12	9
housing material	stainless steel 1.4305, sensor head PEEK (polyetheretherketon), FPM bend protection					

\* 98.5% confidence interval (confidence limit), middle of range as % of range. Resolution dependent on the distance.

### Cable configuration

By default, the probes have a BNC plug for the connection at the eddy current basic module. Optionally the probes are equipped with a LEMO connector. This is necessary for connection to the probe driver with protection class of IP68.



#### Standard version with BNC connector

- BNC connector diameter max. 15 mm

#### Version with LEMO connector for IP68 probe driver

- LEMO connector diameter max. 11 mm

## TECHNICAL DATA – DRIVER



AX Eddy Current Probe Driver	AX1	AX2
channels	1 channel	2 channel
operating temperature range	-40...+85 °C	
storage temperature range	-50...+100 °C	
humidity	100 %	
vibration	5 g, DIN EN 60068-2-6	
shock	15 g / 11 ms, DIN EN 60068-2-27	
protection class	IP40, optional IP68 with LEMO connector	
housing	anodised aluminium sealed with o-ring, mounting bores	
housing size l x w x h	134 x 65 x 30 mm (l x w x h)	
weight	350 g	385 g
<b>Supply</b>		
supply voltage	24 VDC ± 10 %	
current consumption	50 mA	80 mA
power on peek current	n.s.	
reverse polarity protection	yes	
protection circuit	bipolar supressor diode 36 V	
protection circuit	mind. 1 kV	
<b>Analog output</b>		
output signals	0,5 ...10 V	
linearity*	±2 % of full range	
filter corner frequency	10 kHz (-3 dB)	
calibration material	42CrMo4	
temperature coefficient electronic	-0,06 %K	
connection supply / output	M12 connector 4 pole (IP68) for supply / output	
connection sensor	1 x BNC female connector / LEMO (IP68)	2 x BNC female connector / LEMO (IP68)
output protection circuit	varistor	
<b>General data and industrial standards</b>		
electromagnetic compatibility	EN 61326-1 / EN 55011	
RoHS	appropriate standard 2002/95/EG	
MTBF	EN 61709, > 360.000 h	
customs declaration number	90318034 country of origin Germany	

\* driver and sensor are matched and calibrated pairs

# TECHNICAL DRAWINGS

## type T05

**T05-G-KA**

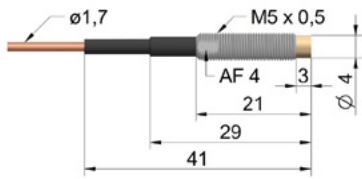

**T05-G-KA-VK10**  
Material: 1.4404

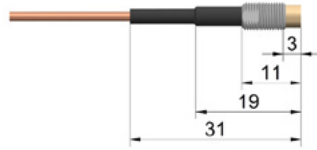

## type T2

**T2-G-KA**

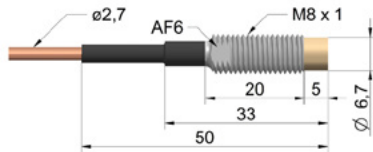

**T2-G-KA-VK23 (short version)**



**T2-G-KA-VL20**

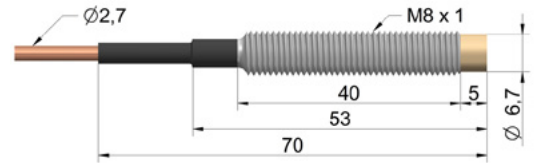

**T2-S-KA**

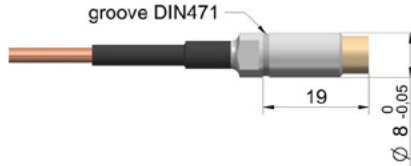

**T2-S-KR**

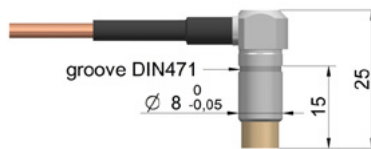

**T2-G-KR**

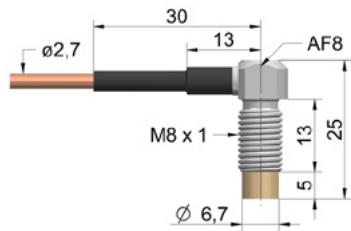

**T2-G-KR-VK7 (short version)**



**T2-G-M12-KA-110-LANG**

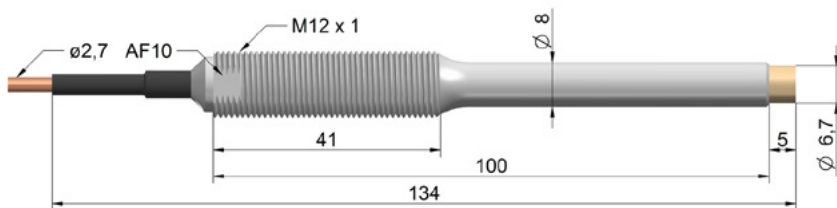

# TECHNICAL DRAWINGS

## type T3

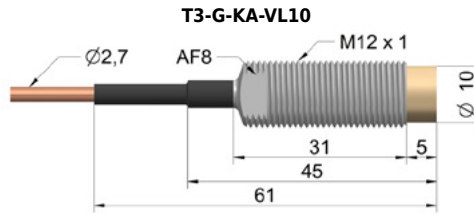
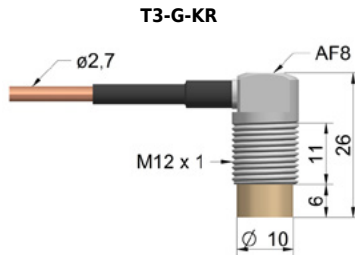
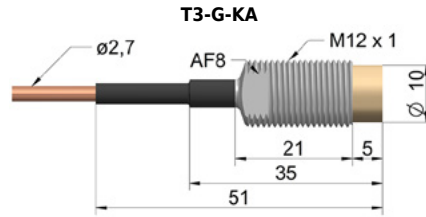
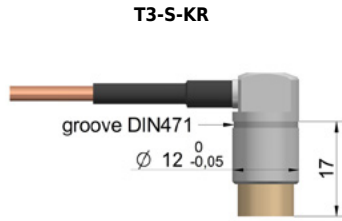

## type T4

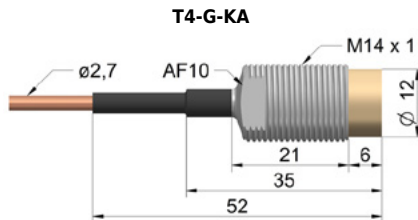

## type T5

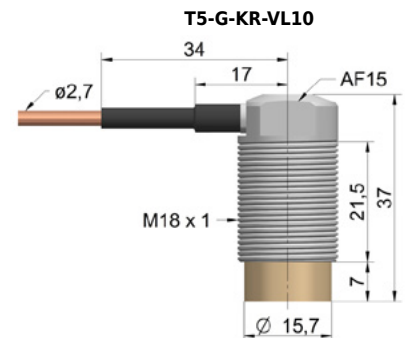
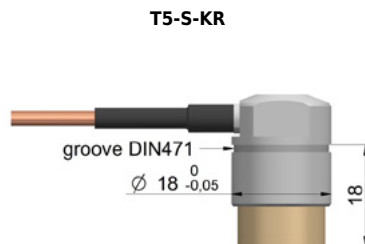
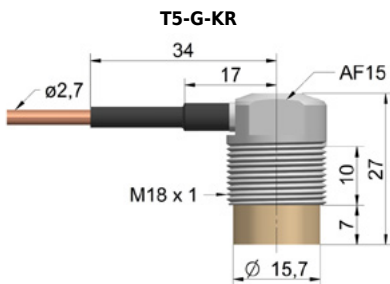
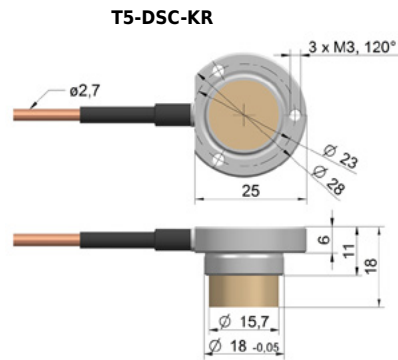
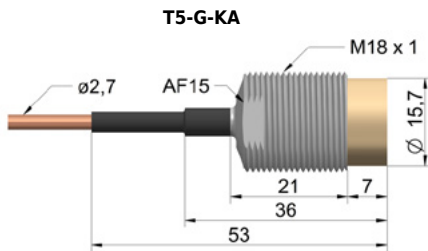

## type T10

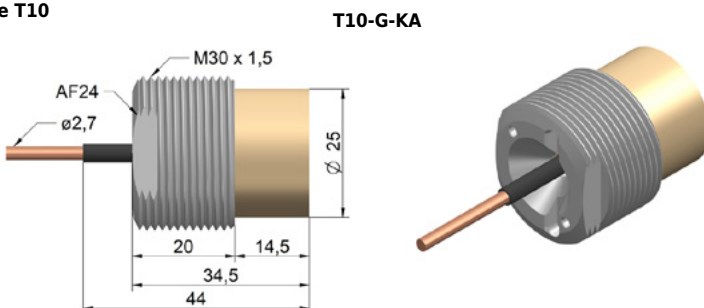

## TECHNICAL DRAWINGS AND CONNECTION

**IP40 Probe driver with BNC connector**

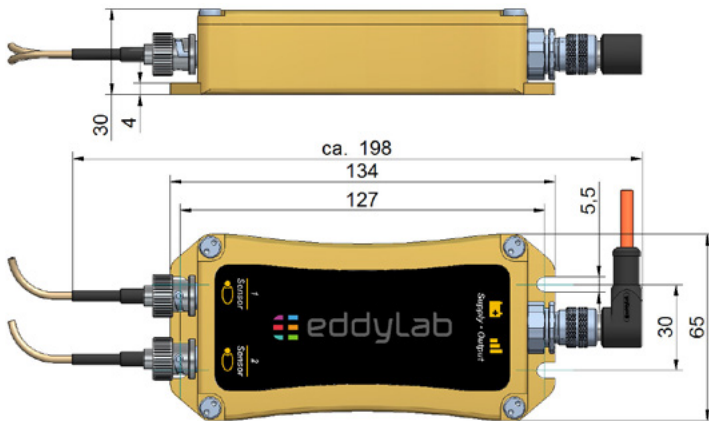

**IP68 Probe driver with LEMO connector**

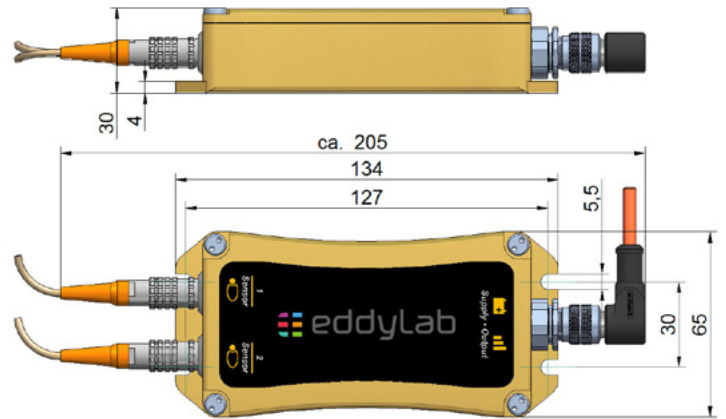

### Supply via 4-pole M12 plug connector (socket)

View of the unit and the soldering side of the mating connector.

Pin 1 (brown)	V+
Pin 2 (white)	signal channel 1
Pin 3 (blue)	GND
Pin 4 (black)	signal channel 2

For connecting the power, shielded cables in various lengths are available (see accessories).

**Please use only shielded supply cables and set the screen on one side (to avoid earth loops)!**



**Note: Wrong connection of supply voltage at the output could damage the unit!**

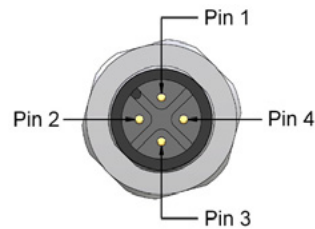

## ACCESSORIES

### Cable for power supply with mating connector M12 straight and angled - K4P

Cable with straight connector:		Cable with angled connector:	
K4P2M-S-M12	2 m	K4P2M-SW-M12	2 m
K4P5M-S-M12	5 m	K4P5M-SW-M12	5 m
K4P10M-S-M12	10 m	K4P10M-SW-M12	10 m





# INSTALLATION

## Electrical installation

Choose a dry location, preferably with a stable temperature for the electrical installation (eddy current basic module) such as electrical cabinets, terminal boxes, housing, etc.

Connect the supply line, probe lines and output lines. Please ensure that all supply and signal lines are laid separately from energy-carrying lines such as supply and discharge lines from converters and drives, lines from ovens and synchronised appliances or generator lines, etc., in order to avoid malfunctions in the signal behaviour.

Please use shielded supply lines only and apply the shield to one side to avoid earth loops.

Please observe the correct assignment of the probes to the respective basic modules and channels. Each individual channel is aligned by the probe as a pair.



## Probe installation

Firstly, install the probe at the relevant installation location and affix the probe using jam nuts or clamp mechanisms. After you have installed the probe, lay the cable. Ensure that the cable is laid without dents and it is not placed under stress. After you have laid the cable into place, do not turn the probe out of the thread, so as to prevent cable damage arising from stress. Secure excess probe cable as far away from temperature influences as possible, i.e. away from electronics. Never shorten the probe cable!

Please note that the probe head must be kept free from neighbouring metallic objects. In order to avoid attenuation of the measuring system, the following locations must not be impaired. In the case of installation into non-metallic and non-conductive materials, this is not necessary.

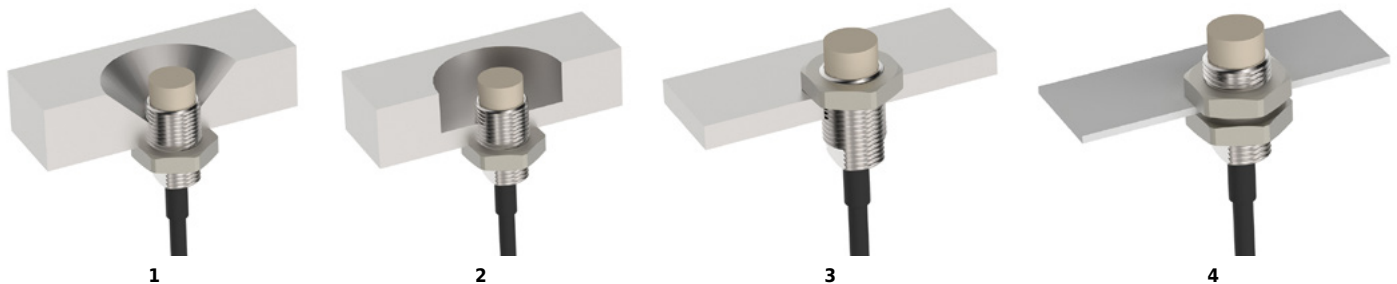

**1)** Installation with 45° countersinking. The diameter of the countersinking must be at least three times greater than the probe head diameter.

**2)** Installation with cylindrical countersinking. The diameter of the cylindrical countersinking must be at least 2-3 times greater than the probe head diameter. The projection of the probe cylindrical bottom: approx. three times the size of the measurement area; however, of at least the length of the PEEK head.

**3) + 4)** Installation into boards or metal with front or rear jam nut. Ideally, ensure there is an additional thread projection of approx. 3 mm to the board or the jam nut. Please note that thin-walled holders can oscillate or vibrate, and the holder's own frequency can interfere with the measurement result. If these locations cannot be kept free of impairment as recommended, it is recommended that a ferrite-shielded probe or a customer-specific linearisation is used. Ferrite-shielded probes are available upon request.

## Object size and the eddy current measurement field

The eddy current measurement field (illustrated in red) is emitted elliptically from the probe level, and is greater than the probe head in terms of its spatial expansion. Therefore, for standard-calibrated probes a two-dimensional object surface with a probe head diameter 2-3 times greater than this is necessary for measurement. If the object is too small, only a part of the measurement field enters the material, and the output signal becomes larger. If the diameter is too small, the object appears to be further away from the sensor. A similar effect takes place in the case of round objects.

However, if other metallic objects force their way into the measurement field (e.g. laterally), the output signal is reduced due to the additional object. The actual object appears to be closer to the probe. If this signal alteration is not desired, we can provide customer-specific linearisation for such applications. In this case, the probe is calibrated directly with the object provided. The measurement area and the linearity are thus re-introduced into the specified area. The object (shape, material) is documented in the calibration document.

The following provides an overview of various geometric object properties:

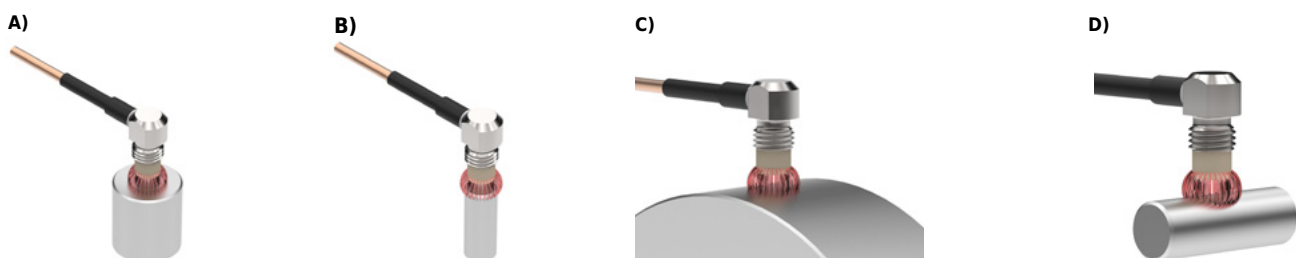

**A)** Optimum object surface, preferably 2-3 times greater than the probe head diameter. The measurement field is captured by the object entirely.

**B)** Reduced object surface, a part of the measurement field remains untouched by the object. The probe displays a greater distance signal than the actual distance. The measurement area is reduced in size. Lateral object movements can influence the distance signal. We can perform a customer-specific calibration in order to correct the measurement area and linearity.

**C)** Large round objects (diameter  $> 8 \times$  probe head diameter) such as cranks or shafts can be captured without significant signal alterations. The probe outputs the medium distance via the captured surface. The measurement area reduces in size by  $< 10\%$ . To correct this, an optional customer-specific calibration can be performed. For example: shaft diameter  $> 8 \times$  probe head diameter  $\leftrightarrow$  measured area reduction  $< 10\%$ , linearity  $< 0.5\%$  of the measured area.

**D)** Small round objects such as shafts or wire (diameter  $< 2 \times$  probe head diameter) can only be captured with a significantly smaller measurement area, insofar as customer-specific calibration has not taken place. For example: shaft diameter  $< 2 \times$  probe head diameter  $\leftrightarrow$  reduction in the measurement area of  $\sim 25\%$ , linearity  $\sim 1\%$ . In this case, we recommend that we perform customer-specific calibration.

## INSTALLATION

### Metallic objects in the measurement field

Please note that metallic objects such as screw heads, bolts, etc., located in the measurement field in both a radial and axial direction (or which cross the measurement field during rotation), can become disturbance variables in the signal.



## PRECAUTIONS

- Never shorten the probe's coaxial cable. The probe, cable and electronic system form a coordinated oscillating circuit.
- Lay the cable so that it is protected and avoid running it along objects with sharp edges. A cable that has been squashed or damaged in a manner can tamper with the signal or render the probe unusable.
- Please note that the sensors have been aligned with the electronic system. The alignment can be found in the calibration record or on the label on the unit, identified by the serial number. Do not switch the channels.
- Avoid placing the cable under tensile or torsional stress. Never turn the probes in the holders inwards or outwards without first loosening the fastenings.
- Observe the minimum bend radius for dynamic and static installation stated in the data sheet. Avoid kinks in the line.
- Protect the plug connections in the coaxial line against humidity and wetness.
- The sensors may not be used in strong radioactive environment (nuclear power plant).



## ORDER CODE PROBES

sensor type

**a**

- X X X

**b**

**c**

**d**

### **a** sensor type

according to technical drawings, p. 4, p. 5 (e.g. T5-G-KA)

### **b** cable length

1 = 3M: 3 m (standard)

### **c** cable end

- 1 = BNC connector (standard)
- 3 = LEMO connector

### **d** others

- 1 = - (standard)

## ORDER CODE DRIVER

AX- [ ] - [ ] - [ ] - [ ]

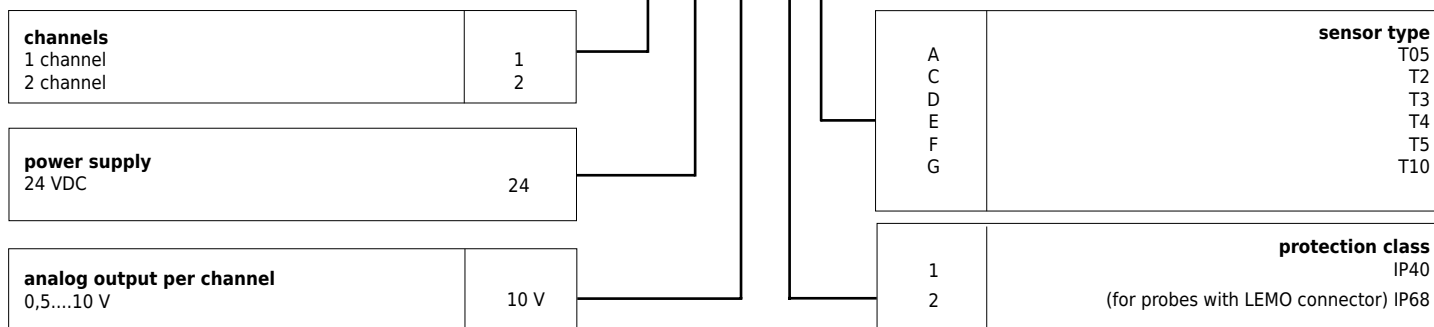

Subject to change without prior notice.