

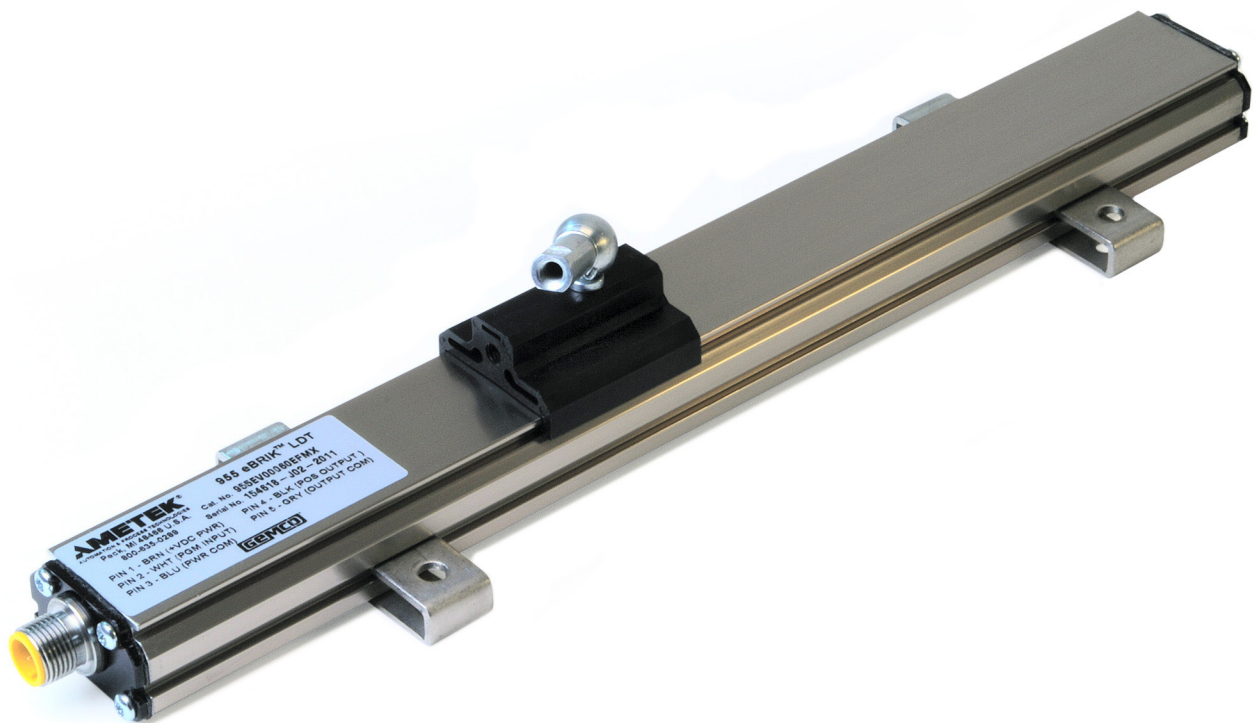

# INSTALLATION MANUAL

LINEAR DISPLACEMENT TRANSDUCERS

## 955 eBrik™



**ABSOLUTE PROCESS CONTROL  
KNOW WHERE YOU ARE... REGARDLESS**





## Introduction

The 955 eBrik™ is an accurate programmable, auto-tuning, noncontact, linear displacement transducer in an economical, low profile package. The transducer utilizes our field proven Magnetostrictive technology to give absolute position, repeatable to 0.001% of the programmable sensing distance. The streamlined anodized aluminum extrusion houses the sensing element and electronics. The magnet moves over the sensing element that determines the position and converts it to an analog output. The transducer can be ordered with 0 to 10 VDC or 4 to 20 mA output. All units are provided with a standard 5 pin 12mm Euro Micro connector.

Units can be ordered in span lengths up to 72 inches long in 1 inch increments. The optional slide magnet is designed to move effortlessly along the transducer in guide tracks, or the standard floating magnet assembly can be positioned up to 1/4" above the unit. A variety of hardware is available for attaching the magnet slide to the moving portion of the process.

The 955 eBrik™ has a few truly unique features. One feature is the LDT's auto-tuning capability, the ability to sense a magnet other than the standard slide magnet and adjust its signal strength accordingly. Another optional feature is that the analog output is programmable over the entire active stroke length. The active stroke area of the LDT lies between the Null and Dead zones.

The 955™ eBrik™ LDT offers a unique diagnostic capability. The normal analog output indicates the position of the magnet within the programmed Span. If the magnet moves beyond the programmed Zero & Span positions, the analog output will be either 3.9mA or 20.1mA for current models and -1VDC or 10.1VDC for voltage output models. If there is a loss of magnet, the output will be 3.8mA on current units and 10.2VDC on voltage units.

## Mounting

The transducer can be mounted vertically or horizontally using the supplied SD0522000 mounting brackets. The mounting brackets slide in the grooves on the lower part of the extrusion and clamp down when tightened. It is recommended to use one mounting bracket on each end and every three feet between.

Ferro-magnetic material, which is material readily magnetized, should be placed no closer than .25" from the sensing surface of the LDT.

## Magnet Assembly

In building the part number you selected the desired magnet assembly and programmability option. Magnet choices were the Floating Magnet or Slide Magnet assemblies. When using the Floating Magnet assembly SD0551500, the magnet should be installed within 1/4" of the sensing surface. The magnet assembly should also be installed in such a manner that it remains an even distance from the aluminum extrusion throughout the entire stroke. Improperly installed magnets can result in output signal non-linearity, or loss of Magnet signal.

## Wiring

Once the LDT has been installed, wiring connections can be made. The 955 eBrik™ uses an industry standard 5 pin 12mm Euro style cordset with a shield, tied to the coupling nut. To reduce electrical noise, the shield must be properly used. Connect the cable's shield to the controller system Ground. The cable shield is connected at the connector end. Always observe proper grounding techniques and isolate high voltage (i.e. 120/240VAC) from low voltage (24 VDC cables).

### Warning: Do not use molded cordsets with LEDs!

It is preferable that the cable between the LDT and the interface device be one continuous run. If you are using a junction box, it is highly recommended that the splice junction box be free of AC and/or DC transient-producing lines. The shield should be carried through the splice and terminated at the interface device end.

NOTE: When grounding the LDT, a single earth ground should be connected to the Power Supply Common (circuit ground). The LDT Power Supply Common should be connected to the Power Supply Common (-) terminal. The LDT power supply (+VDC) should be connected to the power supply positive terminal (+). The LDT cable shield should be tied to earth ground at the power supply. The LDT analog common should not be connected to earth ground and should be used for connection to interface devices only.

The power supply should be dedicated to the LDT to prevent noise and external loads from affecting it. When powering up more than one LDT on a single power supply, each unit will draw approximately 1.1 watts.

The LDT generates an analog output based on position. The 955 eBrik™ offers 16-Bits of resolution, and if the optional was ordered, is fully programmable over the entire active stroke length. Keep in mind that there is a 2.75" Null Zone at the connector end of the LDT and a 2.75" Dead Band at the other end of the LDT that the magnet must stay out of at all times. The units come fully programmed from the factory and do not require re-programming unless desired. The analog output is referenced to the analog common terminal and should not be referenced to any of the other common terminals.

## Typical Wiring

There are two common methods for wiring the 955 eBrik™ to a customer supplied interface device, such as a PLC or panel meter. The two different methods are commonly referred to as Single Ended Input or Differential Input. Differential Input is the preferred wiring method. With the Differential Input, the Analog Common wire is connected to the customer supplied input device and the Power Supply Common is wired separately to the customers supplied power source. When wired using the Differential method, the electrical noise and voltage offset errors produced by the currents running through the Power Supply Common are eliminated. The Power Supply Common and Analog Common are internally connected inside of the 955 eBrik™ LDT.

## Wiring Diagram

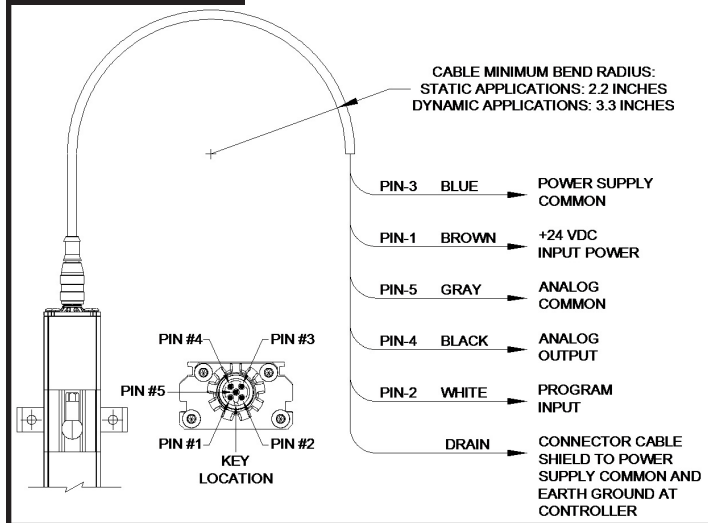

## Differential Input

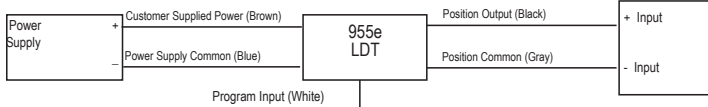

## Single Ended Input

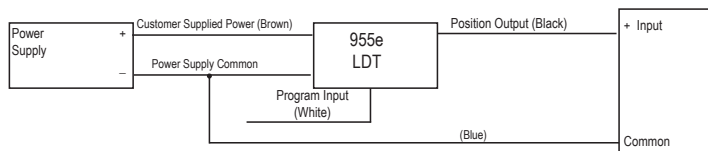

**Note:** The 955e is current sourcing, which allows the current to flow from the LDT into the user's equipment.

## Automatic Gain Control

The Automatic Gain Control feature will automatically search and find the magnet on power up. If power is applied without a magnet on the LDT, turn power off and place magnet within the active stroke area. Re-apply power. If using the Floating magnet option, the magnet should be placed within 1/4" of the LDT's sensing surface, and must be within the active region of the LDT when power is applied.

## Setting ZERO & SPAN

If the programming feature was ordered the 955 eBrik™ is programmable over the entire active stroke length of the LDT. The unit can easily be changed in the field from a 0 to 10VDC to a 10 to 0VDC or 4 to 20mA to a 20 to 4mA. Keep in mind that there is a 2.75" Null area at the connector end of the LDT and a 2.75" Dead band at the other end of the LDT that the magnet must stay out of at all times.

The units come fully programmed from the factory and do not require re-programming unless desired. The units are 100% absolute and will not lose programmed parameters on power loss. The Zero and Span points can be programmed in any order and anywhere within the LDT's active sensor area.  
**NOTE 1:** Zero or Span can be adjusted individually without setting the other.  
**NOTE 2:** Zero = 0V on 0-10 VDC units and 4mA on 4-20mA units. There is a timing sequence that is used to unlock the probe for programming. This is to ensure that the Span cannot be accidentally re-programmed by someone in the field.

Before programming the Zero or Span, the program input must be connected to the Power Supply Common for a minimum of 2 seconds and no more than 6 seconds, and then released for 1 second. The LDT programming sequence is now unlocked and will remain an unlocked unit until either the Zero or Span is programmed or the 10 second programming sequence times out. During the unlock mode either the Zero or Span can be programmed by momentarily connecting the Program Input to either the Power Supply Common or Power Supply +. **NOTE:** The LDT must be unlocked to program the Zero and unlocked again to program the Span. Once either the Zero or Span is programmed, the LDT will go back into the locked mode. To program the Zero or Span, the program input must be connected to the Power Supply Common for 4 seconds, and then released for 1 second. Within the next 5 seconds, you can program either the Zero or the Span by momentarily connecting the Program Input to either the Power Supply Common or Power Supply +VDC.

**WARNING:** During normal operation, electrically insulate the White Program wire to prevent accidental setting of Span.

## Manual Setting ZERO & SPAN

To set the Zero and Span position, follow these steps:

1. Apply power to the LDT
2. Place magnet assembly where Zero is to be located, but within the active region of the probe.
3. Short the Program Input pin to the Power Supply Common for 4 seconds. Remove the short for 1 second. Within 5 seconds, short the Programming Input pin to the Power Supply Common. This completes the Zero programming process.
4. Place magnet assembly where Span is to be located, but within the active region of the probe.
5. Short the Program Input pin to the Power Supply Common for 4 seconds. Remove the short for 1 second. Within 5 seconds, short the Programming Input pin to the Power Supply +VDC. This completes the programming process.

## Optional In-Line Programmer

The 955-1409 is a remote programmer that can help simplify the programming process. The programmer is a portable device that can be temporarily or permanently installed in series with the eBrik™ LDT.

1. Remove the 5 pin cordset to the LDT.
2. Attach the existing cordset to the 955-1409 programmer.
3. Attach the other end to the LDT.
4. Apply power to the LDT.
5. Place magnet assembly where Zero is to be located, but within the active region of the probe.
6. Push the Zero button for 4 seconds. Release the button for 1 second. Within 5 seconds, push the Zero button again.
7. Place magnet assembly where Span is to be located, but within the active region of the probe.
8. Push the Zero button for 4 seconds. Release the Zero button for 1 second. Within 5 seconds, push the Span button.



## Optional Remote Tester & Programmer

To help simplify the programming process we offer a battery operated remote tester / programmer. It is available in either a voltage or current model. P/N SD0528810 is designed for voltage units while SD0528811 is for current units. These units are typically used to demonstrate the functionality of the LDT in the field; however, they can be used as a handy troubleshooting / programming device.

1. Attach the 5 pin Euro connector to the LDT.
2. Push the toggle switch to the ON position to power the LDT.
3. Place magnet assembly where Zero is to be located, but within the active region of the probe.
4. Push the black Zero button for 4 seconds, release for 1 second. Within 5 seconds, push the Zero button again. This completes the Zero programming process.
5. Place magnet assembly where Span is to be located, but within the active region of the probe.
6. Push the black Zero button for 4 seconds, release for 1 second. Within 5 seconds, push the Span button.

**NOTE:** This time the Span button is pushed for the final programming step. This completes the programming process.



## Dimensions

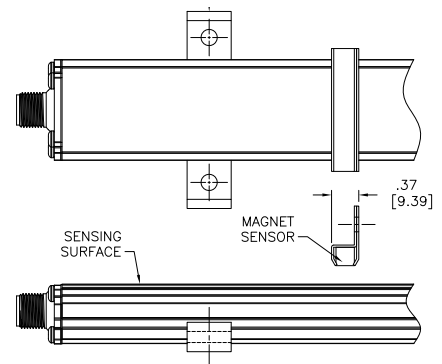
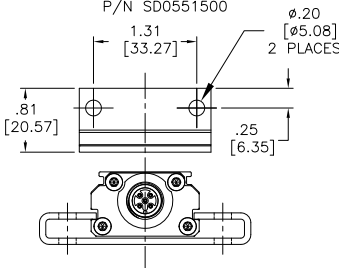
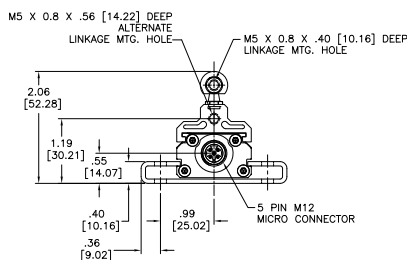
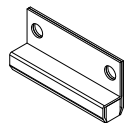
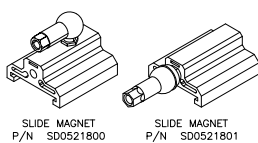
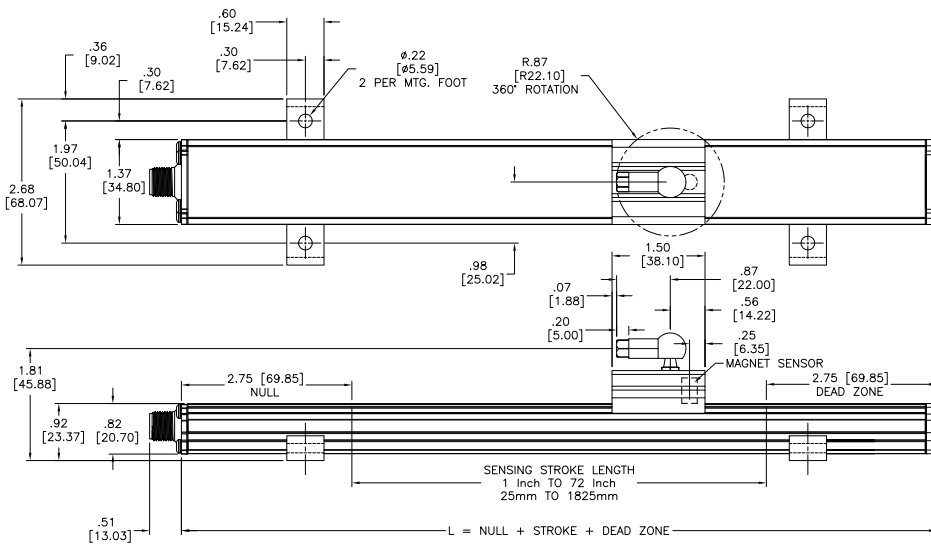

## Part Numbering

**955e** — **V0** — **0120** — **E** — **FM** — **X**

**955 eBrik™**

### Output

V0 = 0 to 10  
V1 = 10 to 0  
C2 = 20 to 4mA  
C4 = 4 to 20mA

### Stroke Length

Insert stroke length to 1 inch or 25mm. Enter as a four-place number.  
**Example:** 12.0 inch stroke is entered as 0120 (E) or 100mm is entered as 0100 (M).

### Units of Measure

E = English US Inches / M = Metric

### Magnet Type

FM = Floating Magnet (Standard)  
SM = Slide Magnet Top Swivel  
SF = Slide Magnet Front Swivel  
X = No Magnet

### Options

X = No Options  
P = Programmable Zero and Span

## Accessories





Item	Part Number
Slide Magnet	SD0521800
Large Float Magnet	SD0551500
Mounting Foot	SD0522000
6 Ft, 5 Pin Straight Cable	949019L6
12 Ft, 5 Pin Straight Cable	949019L12
6 Ft, 5 Pin Right Angle Cable	949020L6
12 Ft, 5 Pin Right Angle Cable	949020L12

Specifications	
<b>General Specifications</b>	
Connector	5-pin 12mm Euro Micro
Displacement	1" to 72" in 1" Increments
<b>Electrical Specifications</b>	
Input Voltage	24 VDC $\pm 20\%$
Current Draw	1.1W (44mA typical)
Dead Band	2.75"
Null Zone	2.75"
Non-linearity	less than $\pm 0.03\%$ of stroke or $\pm 0.013$ ", whichever is greater
Repeatability	0.001%
Hysteresis	less than 0.001"
Operating Temperature:	-40°C to 85°C
<b>Analog Output Specifications</b>	
Voltage Output Minimum Load Resistance	2K Ohms
Output Current	Guaranteed 5mA minimum for voltage units
Analog Ripple	1 mV maximum
Current Output Maximum Load Resistance	500 Ohms
Update Time	1ms
<b>Resolution</b>	
Internal	.00006"
Output	16-bit
<b>Output Type</b>	
Voltage Output	0V to 10V, 10V to 0V
Current Output	4mA to 20mA, 20mA to 4mA
<b>Enclosure Rating - IP-67</b>	
<b>Approvals - CE (EMC)</b>	
<b>Note:</b> Specifications are based on a 48" stroke with floating magnet SD0551500 and 1/8" gap.	

AMETEK Automation & Process Technologies has checked the accuracy of this manual at the time it was approved for printing. However, this manual may not provide all possible ways of installing and maintaining the LDT. Any errors found in this manual or additional possibilities to the installation and maintenance of the LDT will be added in subsequent editions. Any comments you have for the improvement of this manual are welcomed. AMETEK reserves the right to revise and redistribute the entire contents or selected pages of this manual. All rights to the contents of this manual are reserved by AMETEK.

**For customer service or technical support  
call Toll Free 800-635-0289**



Other Products		
	 <ul style="list-style-type: none"> <li>LINEAR DISPLACEMENT TRANSDUCERS</li> <li>PLC INTERFACE PRODUCTS</li> <li>ROTARY POSITION PRODUCTS</li> <li>PROGRAMMABLE LIMIT SWITCHES</li> <li>EXTREME DUTY CABLE REEL PRODUCTS</li> <li>ROTARY LIMIT SWITCHES</li> <li>RESOLVERS</li> <li>MILL DUTY ENCLOSURES</li> <li>ULTRA HIGH SPEED PLS</li> <li>SAFETY PRODUCTS</li> </ul>	
		

Copyright 2011 by AMETEK AUTOMATION & PROCESS TECHNOLOGIES. All Rights Reserved. Made in the USA.



6380 Brockway Rd, Peck, MI 48466  
 Phone: 248-435-0700 Toll Free: 800-635-0289  
 Fax: 248-435-8120 [www.AMETEKAPT.com](http://www.AMETEKAPT.com)

955e.M1R1  
 10/11.Z371

