

ULTRASONIC

Distance and Proximity Sensors



Series UPT

Key-Features:

- Available measurement ranges from 400 to 3500 mm
- Repeatability up to 0.5 mm
- Linearity < 0.5 % of full scale
- Ultrasonic distance sensor or 2 point proximity switch
- Rectangular housing with small dimensions
- Teachable measurement range
- Measurement is independent of the targets material, surface, colour or transparency
- Protection class up to IP67

Content:

Technical Data	...2
Technical Drawing	...2
Teach-in Guide	...3
Electrical Connection	...4
Sound Cones	...5
Order Code	...5

TECHNICAL DATA

		UPT-400	UPT-500	UPT-800	UPT-1600	UPT-2000	UPT-3500
Detection range	[mm]	30...400	60...500	100...800	80...1600	200...2000	350...3500
Repeatability		0.5 mm	0.2 % / 1 mm		0.2 % / 2 mm		
Linearity	[%]					<0.5	
Resolution	[mm]	0.125	0.25	1			
Inverted characteristic curve						yes	
Control inputs						yes	
Safety features		Protection against reverse polarity and short circuit					
Temperature range	[°C]	-20...+70					
Connection		M12 connector					
Dimensions	[mm]	101 x 36 x 32.5					
Housing material		plastics					
Protection class		IP65	IP67	IP67	IP65	IP67	IP67
Angle of the sound cone						8°	

Distance sensor

Response time	[ms]	60	100	140	200	400	
Signal output		0...10 V / 4...20 mA					
Adjustment		by Teach-in mode					
Current consumption (no load)	[mA]	35					
Power supply	[VDC]	15...30					

2 point proximity switch

Response time	[Hz]	15	10	6	5	02.05.13	
Signal output		PNP / NPN					
Hysteresis	[%]	1					
Max. output current	[mA]	500					
Adjustment of switching points		by Teach-in mode					
Current consumption (no load)	[mA]	70					
Power supply	[VDC]	15...30					

TECHNICAL DRAWING

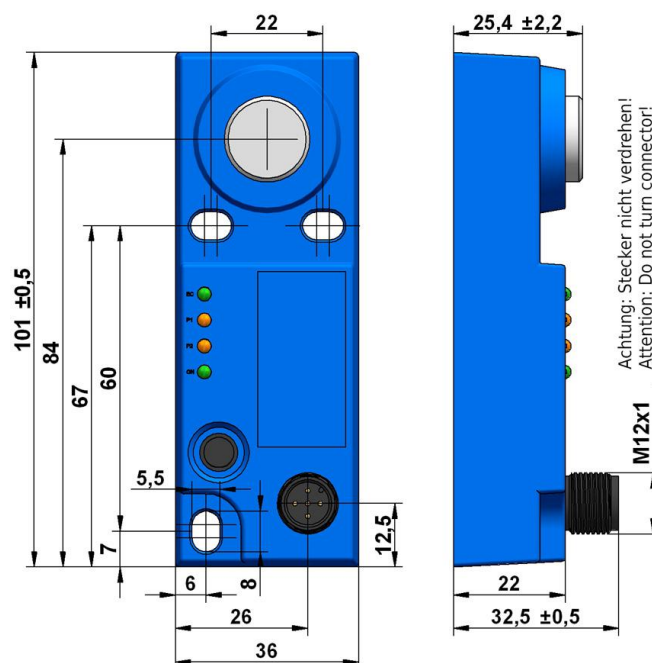

TEACH-IN GUIDE 2 POINT PROXIMITY SWITCH

2 point proximity switch (teach-In)

3 different modes of switching outputs can be selected with this sensor

- Normal switching function
- Window function
- Adjustable hysteresis

All these functions are selected by using the Teach key. Each mode has a different sequence using the Echo, P1 and P2 LEDs.

The different steps are shown in the diagram on the right.

Functions of the sensors control devices:

- EC (Echo LED): is on, when an echo is received (alignment LED).
- P1 LED: Status of the switching output SP1
- P2 LED: Status of the switching output SP2
- ON LED: on if the sensor is connected to power supply
- Teach Key (TK): Button (total teach in time approx. 30 sec.)

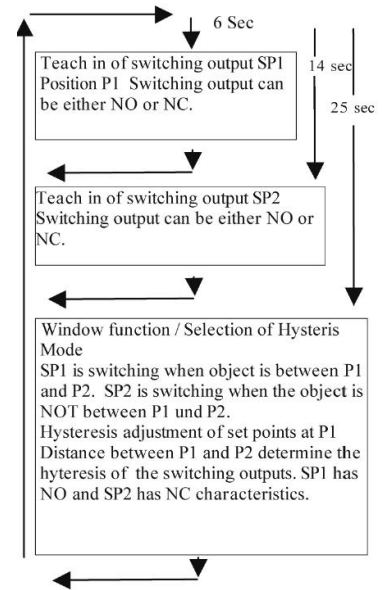

1. Normal switching function:

Setting the switching point P1

1. Press Teach-Key (approx. 6 sec.) until Echo and P1 LEDs start blinking with a 2 Hz frequency. The sensor is now in Teach Mode P1.
2. P1 LED will now blink with 1 Hz frequency and the Echo LED will go back to normal function (alignment LED). There is a time window of 30 sec to do the programming of P1. Place the target at the new position P1. Press Teach Key once: P1 is now stored.
3. Switching output characteristics: Is LED P1 on when pressing the Teach Key, the switching output SP1 will have a NO characteristics, Is LED P1 off when pressing the Teach Key, the switching output SP1 will have a NC characteristics

Setting the switching point P2

1. Press Teach-Key until Echo and P2 LEDs start blinking with a 2 Hz frequency. First Echo and P1 will be blinking, but please wait for P2 to start blinking. The sensor is now in Teach Mode P2.
2. P2 LED will now blink with 1 Hz frequency and the Echo LED will go back to normal function (alignment LED). There is a time window of 30 sec to do the programming of P2. Place the target at the new position P2. Press Teach Key once: P2 is now stored.
3. Switching output characteristics: Is LED P2 on when pressing the Teach Key, the switching output SP2 will have a NO characteristics, Is LED 2 off when pressing the Teach Key, the switching output SP2 will have a NC characteristics

2. Window function / Hysteresis adjustment

1. Press Teach-Key until Echo, P1 and P2 LEDs start blinking with a 2 Hz frequency. Before reaching the hysteresis teach mode, the sensor will go through the P1 and P2 teaching sequence. So please keep the Teach-Key pressed until reaching the point when all LEDs are blinking. The sensor is now in teach mode for Window function / Hysteresis adjustment.
2. P1 and P2 are blinking now with a 1 Hz frequency and EC is in normal function (alignment LED). There is a time window of 30 sec to do the programming.
 - 2.1. Press and release the Teach-Key: P1 and P2 are OFF during pressing the Teach-Key, the sensor will operate in the Windows function. Is there an object between P1 and P2, SP1 will switch ON and SP2 will switch OFF. Is there no object between P1 and P2, SP1 will switch OFF and SP2 will switch ON.
 - 2.2. If P1 and P2 are ON during contact the sensor will operate in Hysteresis mode. The switching output SP1 will be (NO) at P1 with hysteresis P1-P2 and switching output SP2 will be (NC) also at P1 with hysteresis P1-P2.

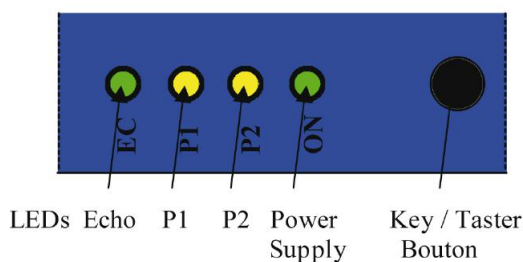

Normal Switching Operation

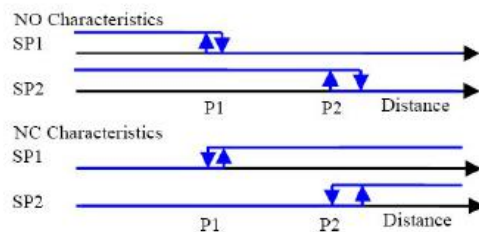

Windows Function

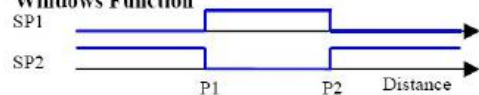

Hysteresis Adjustment

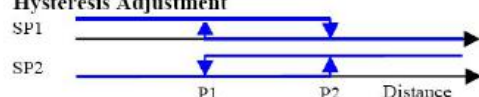

TEACH-IN GUIDE DISTANCE SENSOR ANALOG OUTPUT

Analog output 0...10 V / 4...20 mA (teach-In)

Functions of the sensors control devices:

- EC (Echo LED): is on, if an echo is received (alignment LED).
- P1, P2 LED: either P1 or P2 is On if there is no object between P1 and P2.
- ON LED: On if the sensor is connected to power supply
- Teach Key (TK): Button (total teach in time approx. 30 sec.)

Positive slope: P1<P2

Negative slope: P2<P1

Teach Mode P1 (Position 0 V, respectively 4 mA)

1. Press Teach-Key (approx. 6 sec.) until EC (Echo LED) and P1 are blinking with a 2 Hz frequency. The sensor is now in Teach Modus P1.
2. Release Teach-Key: now P1 blinks with a 1 Hz frequency and EC LED is in function (alignment LED). There is a time window of 30 sec to teach the P1 position. Place the target at the desired position P1 (0 V / 4 mA). Press Teach-Key shortly. P1 is now stored. The sensor now returns into normal function with a new value for P1.

Teach-In Mode P2 (Position 10 V, respectively 20 mA)

3. Press Teach-Key (approx. 15 sec.) until EC (Echo LED) and P2 are blinking with a 2 Hz frequency. First Echo and P1 will be blinking, but please wait for P2 to start blinking. The sensor is now in Teach Modus P2.
4. Release Teach-Key: now P2 blinks with a 1 Hz frequency and EC LED is in function (alignment LED). There is a time window of 30 sec to teach the P2 position. Place the target at the desired position P2 (10 V / 20 mA). Press Teach-Key shortly. P2 is now stored. The sensor now returns into normal function with a new value for P2.

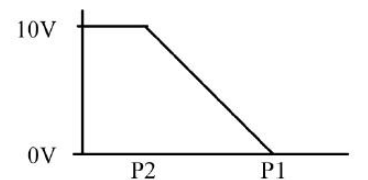
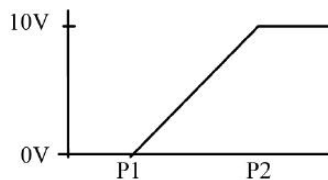
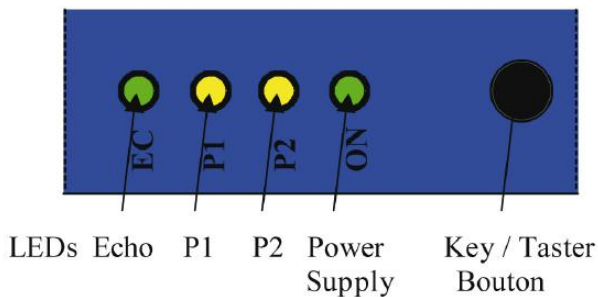

P1: determines the position where the characteristic line takes the value 0 V or 4 mA
 P2: determines the position where the characteristic line takes the value 10 V or 20 mA

With these two points the working range of the analog characteristic line is configured.

ELECTRICAL CONNECTION

Analog output

PIN assignment

PIN 1	+24 V
PIN 2	n.c.
PIN 3	0 V / GND
PIN 4	Analog
PIN 5	HOLD / SYNC

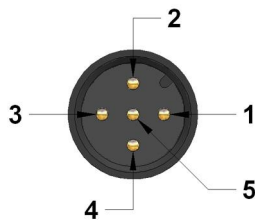

Output proximity switch

PIN assignment

PIN 1	+24 V
PIN 2	SP2
PIN 3	0 V / GND
PIN 4	SP1
PIN 5	HOLD / SYNC

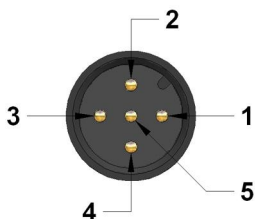

Connection cable

Cable with M12 connector, 5 pole, shielded, IP67

K5P2M-S-M12	2 m, M12 connector straight
K5P5M-S-M12	5 m, M12 connector straight
K5P10M-S-M12	10 m, M12 connector straight
K5P2M-SW-M12	2 m, M12 connector angular
K5P5M-SW-M12	5 m, M12 connector angular
K5P10M-SW-M12	10 m, M12 connector angular

PIN cable colour

1	brown
2	white
3	blue
4	black
5	grey

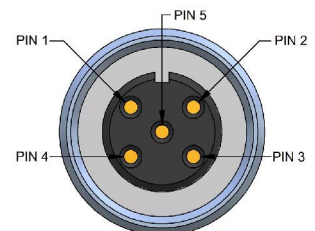

SOUND CONE GEOMETRY

The exact geometry of the sound cone depends on the air-pressure, temperature, humidity and size of the target.

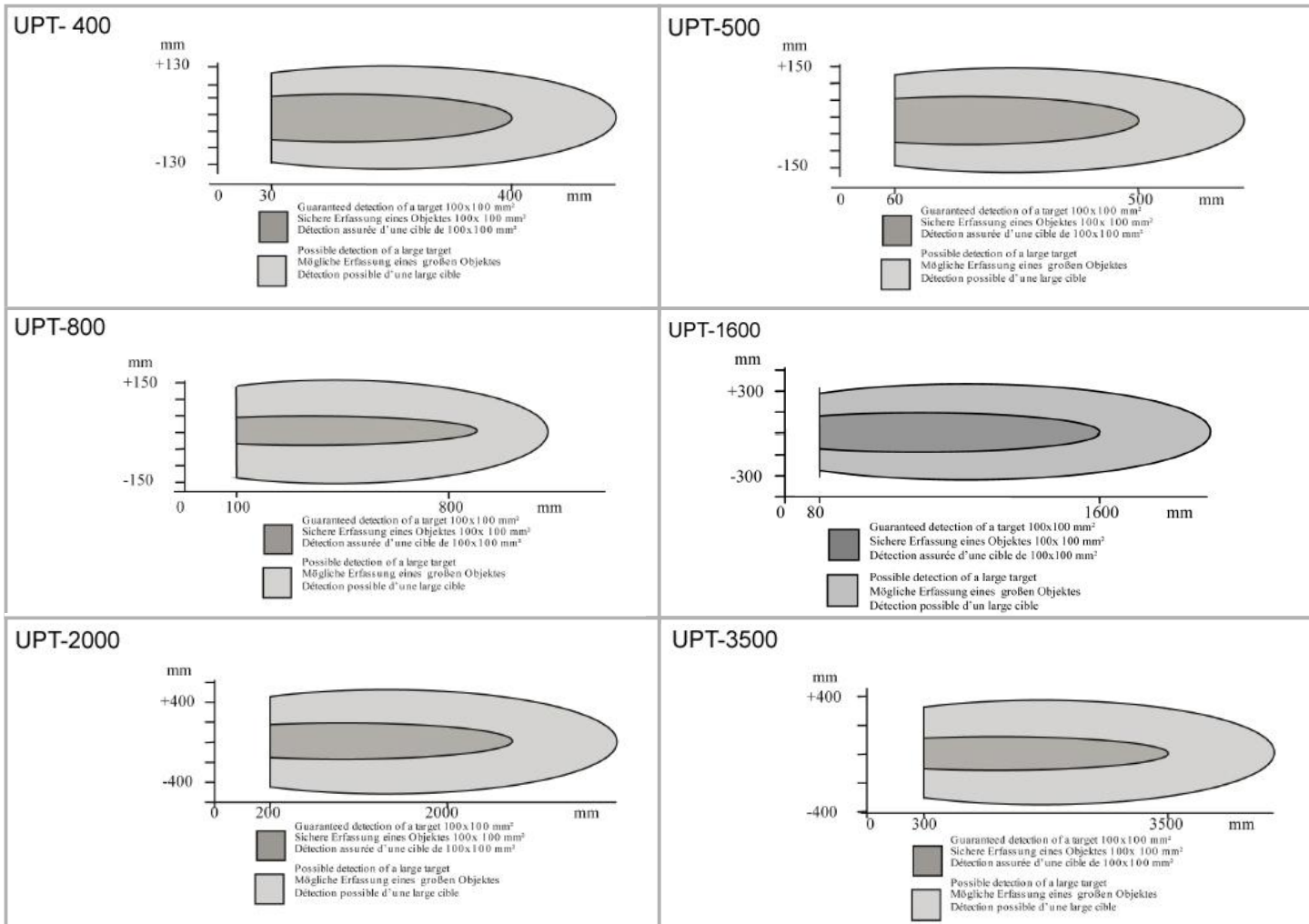

ORDER CODE

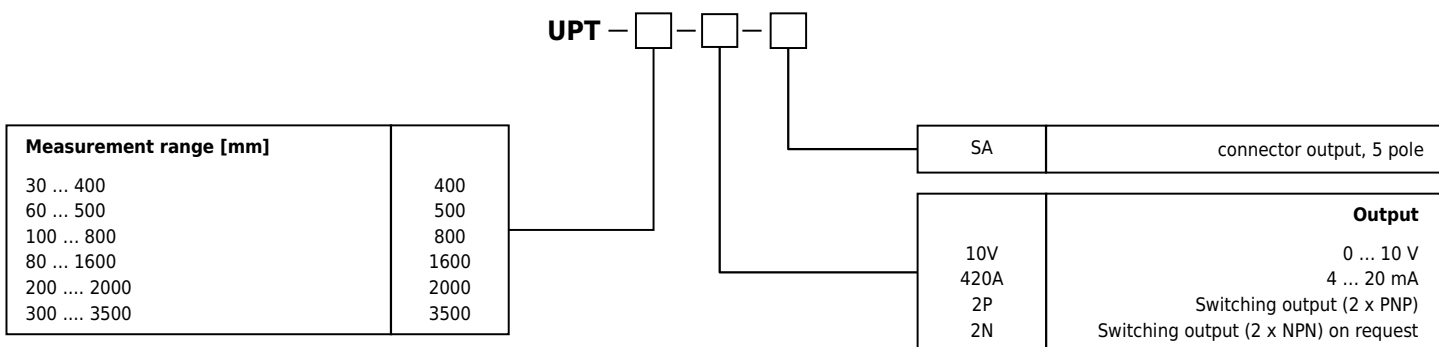

Warning, Safety Information

These devices are not designed for critical safety or emergency shut-down purposes. Therefore they should never be used in an application, where a malfunction of the device could cause personal injury.

Subject to change without prior notice.

WayCon Positionsmesstechnik GmbH

E-Mail: info@waycon.de
 Internet: www.waycon.de

Head Office

Mehlbeerenstr. 4
 82024 Taufkirchen
 Tel. +49 (0)89 67 97 13-0
 Fax +49 (0)89 67 97 13-250

Office Köln

Auf der Pehle 1
 50321 Brühl
 Tel. +49 (0)2232 56 79 44
 Fax +49 (0)2232 56 79 45