

ULTRASONIC

Ultrasonic Distance and Proximity Sensors



UFA-1500 Series

Key features:

- Measurement range 120 to 1500 mm
- Distance sensor or 1-point proximity switch
- Teachable measurement range
- Linearity <1% of full scale
- Resolution approx. 0.5 mm
- Working temperature 0 to +60 °C
- Measurement regardless of material, surface, colour and transparency of the target
- Protection class IP67
- Waterproof, oil-resistant
- Configurable size of sound cone
- Configurable as scanner or reflection barrier
- Chemical-resistant version available
- ATEX version zone 2, zone 22 available on request

Content:

Technical Data2
Adjustments3
Chemical-resistant Version4
Connection & Teach-In5
Order Code & Accessories6

TECHNICAL DATA

		UFA-1500-M18-A / AR Distance sensor	UFA-1500-M18-1P / 1PR Proximity sensor
Measurement range MR	[mm]	120...1500	120...1500
Switching point hysteresis, axial	[mm]	-	2
Linearity	[% MR]	<1	-
Resolution	[mm]	approx. 0.5	
Linearity over full temperature range *	[% MR]	<2	
Operating frequency	[Hz]	approx. 180	
Status indicator		LED yellow / red	
Switching output, short circuit proof, max. load 0.1 A		-	PNP closer / opener
Switching speed, max.	[Hz]	approx. 5	
Analog output frequency	[Hz]	approx. 30	-
Analog output	[V]	0...10 (R _{min} 10 kOhm)	-
	[mA]	4...20 (R _{max} 400 Ohm)	-
Voltage supply (reverse polarity protection)	[VDC]	11...30	
Ripple of supply voltage	[%]	10	
Mean current consumption	[mA]	approx. 45...65	approx. 45
Temperature range	[°C]	0...+60	
Pressure area	[mbar]	900...1100	
Protection class		IP67	
Weight	[g]	approx. 65	
Housing material		Nickel-plated brass	
Explosion protection		ATEX version, zone 2, zone 22 available on request	
Electrical connection		M12 connector, 4-pole	

* linearity can be further improved by only teaching the sensor in a heat-resisting state (e.g. 30 minutes after switching on).

TECHNICAL DRAWING

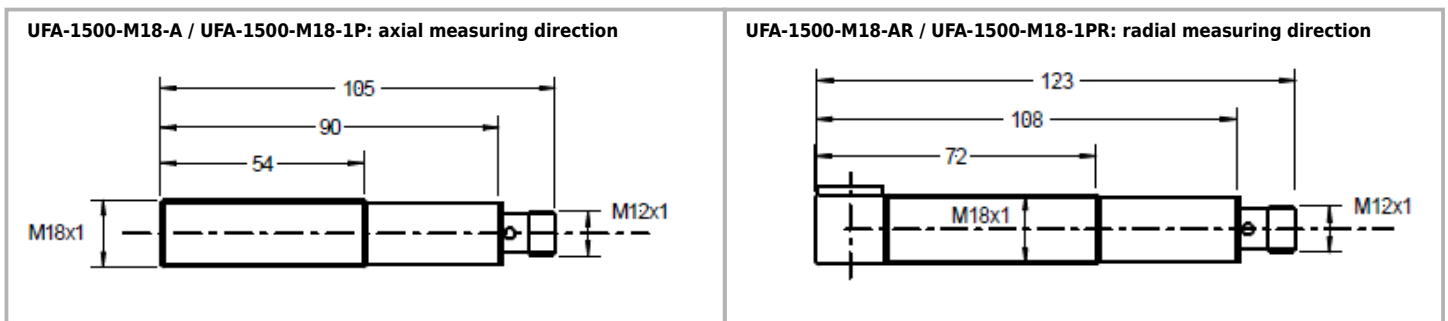

SOUND CONE

The detection beam of an ultrasonic sensor has the shape of a cone. The size depends on the target and its sound reflecting characteristics. Small and poorly reflecting objects result in a smaller cone (narrower and shorter). Bigger objects and those with surfaces which are not perpendicular to the central axis can expand the cone. The exact cone shape and size can be determined only at the object itself. No disturbing objects must be between the sensor and the target within the cone. Otherwise the sensor would detect the disturbing object instead of the desired target. The diagram shows the three typical cone shapes of the UFA-1500 sensors (small, medium and large cone). Furthermore the size of the detection beam is influenced by air temperature and humidity. The colder and dryer the air, the larger is the beam. On UFA-1500 sensors three different cones can be programmed by the user. This is e.g. helpful when sensing into small containers or between narrow gaps.

The cone size is set by connecting the teach input for >5 s with the power supply -U_B (0V). See also the teach table at page 5:

- Small cone: Teach 5...10s with -U_B (yellow LED blinks fast)
- Medium cone: Teach 10...15s with -U_B (yellow/red LED blinks fast)
- Large cone: Teach 15...20s with -U_B (red LED blinks fast)

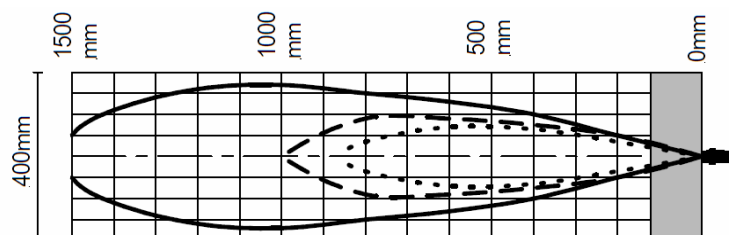

SETTING THE SWITCHING POINTS IN SCANNING MODE

In scanning mode the target reflects a portion of the ultrasound, which in turn is detected by the sensor. The switching points are set by attaching the voltage supply $-U_B$ (0 V) or $+U_B$ (+24 VDC) during 1...5 s to the Teach input.

During the learn-in process a flashing LED indicates whether the sensor detects the target.

- Yellow flashing LED: detected
- Red flashing LED: not detected

<p>Window operation closer NO:</p> <ul style="list-style-type: none"> • Set target to near switching point • Teach switching point 1...5 s with $-U_B$ • Set target to far switching point • Teach switching point 1...5 s with $+U_B$ 	<p>Window operation opener NC:</p> <ul style="list-style-type: none"> • Set target to near switching point • Teach switching target at 1...5 s with $+U_B$ • Set target to far switching point • Teach switching point 1...5 s with $-U_B$
<p>Switching point closer NO:</p> <ul style="list-style-type: none"> • Set target to switching point • Teach switching point 1...5 s with $+U_B$ • Point sensor at space (>1.5 m) • Teach 1...5 s with $-U_B$ 	<p>Switching point opener NC:</p> <ul style="list-style-type: none"> • Set target to switching point • Teach switching point 1...5 s with $-U_B$ • Point sensor at space (>1.5 m) • Teach 1...5 s with $+U_B$

SETTING SWITCHING POINT IN RETROFLECTIVE MODE

Retroflective mode uses a reflector in the background (max. 1.5 m from the sensor). Unlike optical sensors the reflector can be any material which is somewhat sound-reflecting. Retroflective mode is used in place of scanning mode if the target is at a very sharp angle to the sensor beam (see drawing), or is extremely sound-absorbing (no evaluable signal would be reflected from the target to the sensor). In this mode the sensor permanently checks whether it sees the reflector or if it is covered by the target. Likewise, the sensor has no blind range in this operating mode.

In reflection barrier mode the reflector is taught as follows:

<p>Closer NO:</p> <p>Teach 5...10 s with $+U_B$ (Rapid flashing yellow LED)</p>
<p>Opener NC:</p> <p>Teach 10...15 s with $+U_B$ (Rapid flashing red LED)</p>

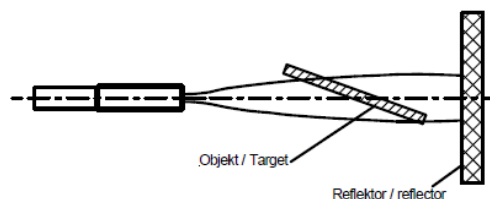

SETTING THE ANALOG OUTPUT MEASURING LIMITS

The two measuring limits are set by attaching the voltage supply $-U_B$ (0 V), or $+U_B$ (+24 VDC) to the Teach input for 1...5 s. During the teaching process the flashing LED indicates if the sensor detected the target.

- Yellow flashing LED: detected
- Red flashing LED: not detected

$-U_B$ teaches the lower evaluation limit (0 V or 4 mA) and the upper evaluation limit with $+U_B$ (10 V or 20 mA). It can be used to program a rising or falling ramp

- Position the target at the lower measuring limit (i.e. where 0 V or 4 mA is desired)
- Teach lower limit 1...5 s with $-U_B$
- Position the target at the upper measuring limit (i.e. where 10 V or 20 mA is desired)
- Teach upper limit 1...5 s with $+U_B$

Upper and lower measuring limits can also later be programmed individually.

Attention:

The Teach wire/input must be disconnected after the Teaching process is completed. The sensor can therefore also be operated with a 3-wire cable after teaching.

CHEMICAL-RESISTANT VERSION UFA-1500-M30-A-CH / -1P-CH

- Based on the UFA-1500-M18 series
- Resistant to most chemicals, e.g. acids and alkalis
- Front of housing made from PVDF
- Membrane protected with PTFE foil
- For level measurement or -monitoring aggressive mediums

Description:

UFA-CH sensors are designed specifically for use in chemically harsh environments. The high resistance corresponds to that of PVDF, or of PTFE. One possible application is level metering acids and alkalis in small containers. The front exposed to the medium consists of PVDF. What makes these chemical-resistant sensors special is that the ultrasonic converter is fully encased in a special PTFE film which allows ultrasound waves to pass through.

Technical data correspond to those of UFA-1500-M18 sensors. (See page 2)



INSTALLATION

Mount to the flange with 6 M4 screws, or

Mount to the G1 thread. Sealing with the included Viton O-rings.

Ultrasonic sensors should be „mounted“ as flexibly as possible to keep acoustic interference away from the installation site. The included rubber rings for a Ø 21 mm installation hole should be used at any rate.

Inclination Angle:

Smooth surfaces can be detected up to an inclination angle of approx. 10 degrees. Rough and heavily textured surfaces can be detected at significantly higher angles. In retroreflective mode the angle does not matter at all.

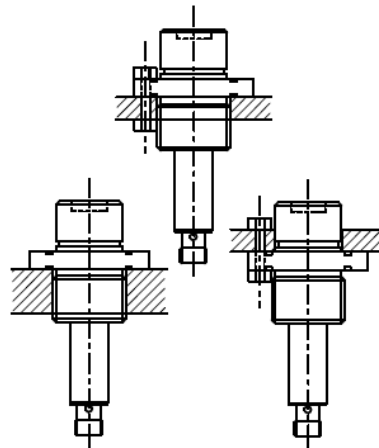

TECHNICAL DRAWING

UFA-1500-M30-A-CH / UFA-1500-M30-1P-CH

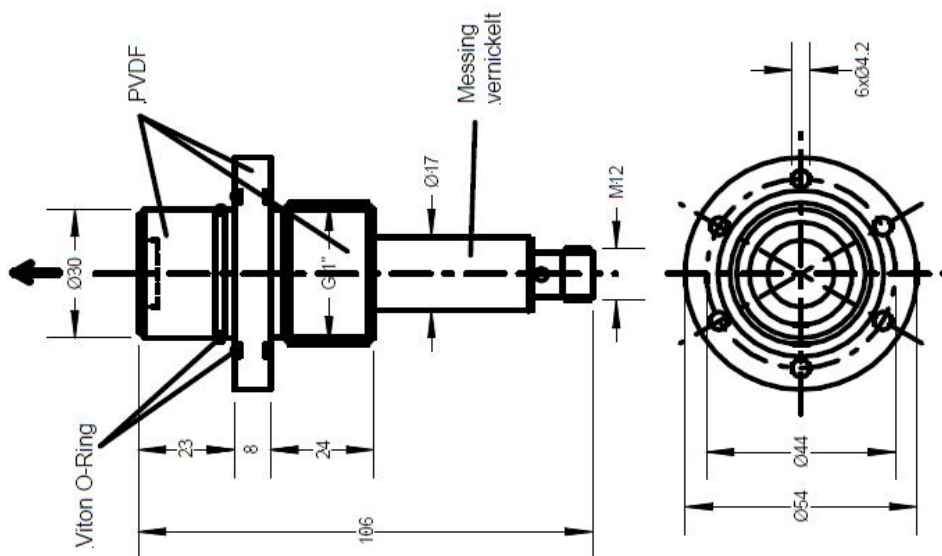

ELECTRICAL CONNECTION

The sensors feature a 4-pole M12 connector. The cables should never be mounted parallel or close to high current cables. Please order the necessary cables separately (see accessories).

PIN assignment: UFA-1500-M18-A / AR

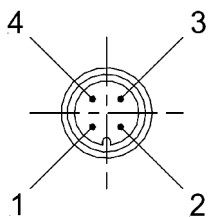

- 1 +24 VDC (brown)
- 2 Teach (white)
- 3 0V (blue)
- 4 OUT 0...10 V (black)

PIN assignment: UFA-1500-M18-1P / 1PR

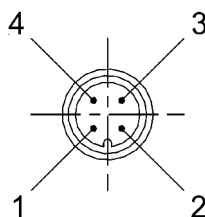

- 1 +24 VDC (brown)
- 2 Teach (white)
- 3 0V (blue)
- 4 OUT PNP (black)

Connection cable (accessory)

Cable with connector M12, 4 poles, shielded

K4P2M-S-M12	2 m, connector straight
K4P5M-S-M12	5 m, connector straight
K4P10M-S-M12	10 m, connector straight
K4P2M-SW-M12	2 m, connector angular
K4P5M-SW-M12	5 m, connector angular
K4P10M-SW-M12	10 m, connector angular



PIN No.	cable colour	PIN No.	cable colour
Pin 1	brown	Pin 3	blue
Pin 2	white	Pin 4	black

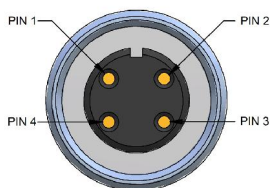

Mating connector (accessory)

Mating Connector M12, 4 poles, shielded

D4-G-M12-S	straight, M12 for self assembly
D4-W-M12-S	angular, M12 for self assembly
protection class: IP67	
temperature: -25...+90 °C	
cable passage: \varnothing 4...8 mm	
wire cross-section: 0.14...0.34 mm ²	
mode of connection: spring cage	



TEACH TABLE

TIME	Connect Teach input to	LED flashes	Switching output version	Analog output version
1 to 5 s	+U _B (typ. +24 VDC)	slow yellow	Closer NO: far window point, or switching point Opener NC: close window point	10 V or 20 mA
1 to 5 s	-U _B (0 VDC)	slow yellow	Closer NO: near window point Opener NC: far window point, or switching point	0 V, or 4 mA
5 to 10 s	+U _B (typ. +24 VDC)	fast yellow	Retroreflective barrier closer NO	-
10 to 15 s	+U _B (typ. +24 VDC)	fast red	Retroreflective barrier opener NC	-
5 to 10 s	-U _B (0 VDC)	yellow	small detection cone	small detection cone
10 to 15 s	-U _B (0 VDC)	yellow / red	medium detection cone	medium detection cone
15 to 20 s	-U _B (0 VDC)	red	large detection cone	large detection cone
>20 s	-U _B (0 VDC)	No LED	Factory reset	Factory reset

ORDER CODE

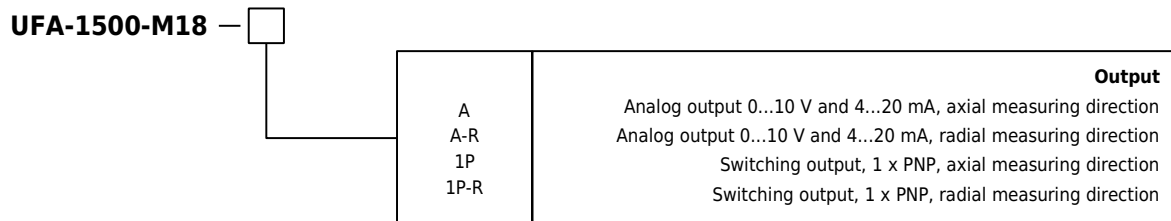

on request: - switching output 1x NPN
- ATEX version, zones 2, 22 (only with axial measuring direction)

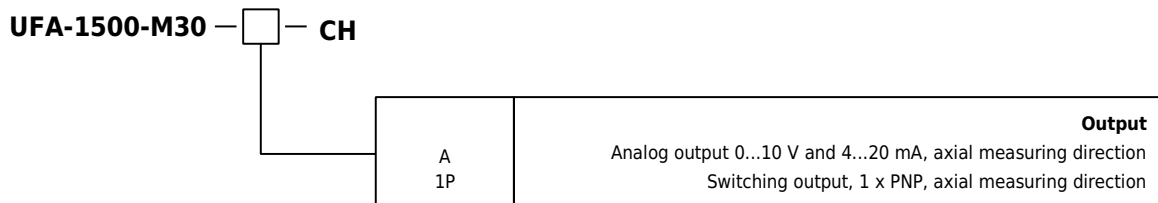

OVERVIEW

UFA-1500-M18-A

UFA-1500-M18-A-R

UFA-1500-M18-1P

UFA-1500-M18-1P-R

UFA-1500-M30-A-CH

UFA-1500-M30-1P-CH

ACCESSORIES

Cable with mating connector M12, 4 poles, shielded

K4P2M-S-M12 2 m, straight connector

K4P5M-S-M12 5 m, straight connector

K4P10M-S-M12 10 m, straight connector

K4P2M-SW-M12 2 m, angular connector

K4P5M-SW-M12 5 m, angular connector

K4P10M-SW-M12 10 m, angular connector

Mating Connector M12, 4 poles, shielded

D4-G-M12-S straight, M12 for self assembly

D4-W-M12-S angular, M12 for self assembly

Digital display 1 channel, 0...10V/4...20 mA

PAXP000B 1 channel, supply: 85 to 250 VAC

PAXP001B 1 channel, supply: 11...36 VDC/24 VAC

Digital display 2 channels, 0...10V/4...20 mA

PAXDP00B 2 channels, supply: 85 to 250 VAC

PAXDP01B 2 channels, supply: 11...36 VDC/24 VAC

For further information please see the data sheet of the PAXD display series



!! WARNING - PERSONAL INJURY !!

Never use these products as safety- or emergency shut-off devices, nor in other applications where a malfunction of this product may result in personal injury. Failure to follow this notice may result in serious or fatal injury.

Subject to change without prior notice.

WayCon Positionsmesstechnik GmbH

E-Mail: info@waycon.de

Internet: www.waycon.de

Head Office

Mehlbeerenstr. 4

82024 Taufkirchen

Tel. +49 (0)89 67 97 13-0

Fax +49 (0)89 67 97 13-250

Cologne Office

Auf der Pehle 1

50321 Brühl

Tel. +49 (0)2232 56 79 44

Fax +49 (0)2232 56 79 45